

CHAPTER 2

PROJECT DESCRIPTION

INTRODUCTION

This chapter describes NGGL's Ahafo South Project to mine and process ore reserves located in the Brong Ahafo Region of Ghana, West Africa. The Ahafo South Project involves development of ore reserves at the southern end of southwest-to-northeast trending mineralized zone extending approximately 70 kilometers (km) in the western portion of Ghana. Current resources are estimated at 105 million tonnes (Mt) of ore producing 6.8 million ounces of gold. Initial development (South Project area) involves approximately 2,174 hectares (ha) for construction and operation of mine facilities.

Detailed discussions of the following topics are presented in this chapter:

- History of mining in Ghana;
- Detailed description of NGGL's Ahafo South Project;
- Employment;
- External affairs management;
- Environmental management; and
- Occupational health and safety.

The Ahafo South Project is currently in development, including construction of the mill facility, tailing storage facility, water storage facility, construction camp, resettlement villages, and access roadways. The Ahafo South Project has received the necessary mining leases and licenses from the Ghanaian EPA to proceed with project development. A variety of alternatives including facility locations, facility design, operational options, and closure/reclamation options were considered in designing and permitting the Ahafo South Project; both by previous mine lease holders and NGGL's recently completed permitting of the Project. Alternatives that have been considered in development of the Project are described in detail in Chapter 3 – *Alternatives*. NGGL has selected the best environmental and least social impacting alternative to implement for development of the Ahafo South Project.

Other potential alternatives have been developed for reclamation and closure of specific mine components and these are also identified in Chapter 3 - *Alternatives*. In addition, alternatives may be considered relative to subsequent development of the Ahafo North area and/or other adjacent mining reserves that may be identified during on-going exploration.

HISTORY OF MINING IN GHANA

West Africa has been a key source of gold for two thousand years. Initially, the gold reached the Mediterranean by camel caravan across the Sahara desert. By 1460 Portuguese navigators were shipping African gold back to Europe directly, and later English and Dutch ships brought gold to London and Amsterdam. Ashanti goldsmiths in Ghana were famed for their distinctive ornaments by the 1500s.

Exploration and gold mining in Ghana began shortly after 19th century European colonization. In 1877, the first European gold concession was issued in Tarkwa area and in 1897 Ashanti Goldfields Corporation Ltd. was founded. The Ghana Chamber of Mines is Africa's second oldest – its forerunner, the West Africa Chamber of Mines, dates from 1903. The Chamber promotes and protects the interests of the mining industry in Ghana and provides leadership to address national mining issues. Other major mines that were started about the same time include: Abooso (1896); Bibiani (1901); Prestea (1903); and Tarkwa (1909).

Gold production declined sharply during World War I and did not recover until after the Second World War. The 1986 Minerals and Mining Law (PNDCL 153), as amended by the Minerals and Mining (Amendment) Act, of 1994 (Act 475), was instrumental in attracting more than \$4 billion in foreign investment to the Ghanaian mining industry through 2000. Act 475 reduced the 45 percent general mining corporate tax rate to 35 percent, which is the same as that imposed on other industries. Concerned with the drop-off in investment in the mining sector since 1999, the Ministry of Lands, Forestry, and Mines has prepared draft legislation, which has been submitted to Parliament in mid-2002, to revise PNDCL 153 to enhance Ghana's international competitiveness.

By 2002 formal mining and quarrying accounted for approximately 25 percent of the Gross Domestic Product (GDP) and employed about 14,000 workers (less than 1% of the work force). Ghana has become the second largest gold producer in Africa after South Africa, the third-largest African producer of aluminum metal and manganese ore, and a significant producer of bauxite and diamond. In addition, a number of industrial minerals, which include clays (kaolin), dimension stone, limestone, salt, sand and gravel, and silica sand, are produced on a small scale (Barning 1997).

With mine closure and consolidation of the industry, two companies accounted for 80 percent of gold production during 2002. AngloGold Ashanti Corporation (formerly Ashanti Goldfields Co. Ltd.) accounted for 43 percent of production from its Bibiani, Iduapriem/Teberebie, and Obusasi Mines, and Gold Fields Ghana Ltd. accounted for 37 percent from its Tarkwa and newly acquired Damang Mines. By the end of 2003, 34 prospecting licenses were granted to both Ghanaian and foreign-controlled companies, and valid exploration licenses stood at 152. Existing, proposed, and previous gold mining operations in southwest Ghana are shown on **Figure 2-1**. Major gold production through 2003 is shown in **Table 2-1**.

The gold sector was going through a transitional phase of mine closures and corporate consolidations, which was expected to last through 2005; as a result, production dropped to as low as 60 tonnes per year of gold. Stimulated by rising gold commodity prices and the infusion of new capital by AngloGold, Newmont, and Golden Star Resources over the next several years, gold production is expected to increase to 84 tonnes/year by 2009; this would consolidate Ghana's position as the second largest producer in Africa.

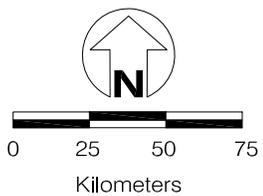
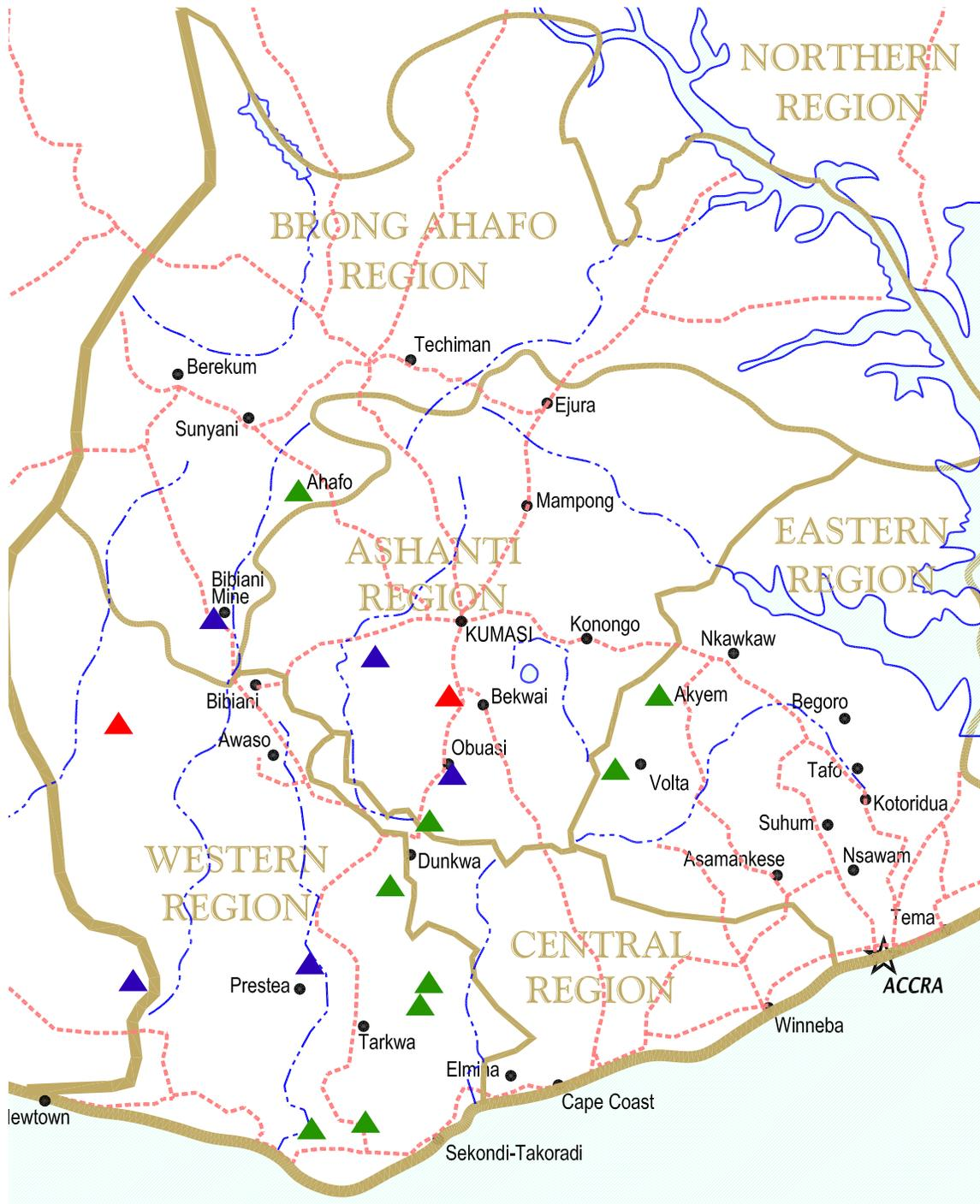

-  Producer
-  Past Producer
-  Exploratory
-  Stream
-  Road
-  Region Boundary

Gold Mining Operations in Ghana
Ahafo South Project
Brong Ahafo Region, Ghana
FIGURE 2-1

Mine	Major Shareholder	Production (oz/tonnes)
Tarkwa	Gold Fields Ghana	561,891/15.9
Obuasi	Anglogold Ashanti	513,163/14.5
Damang	Gold Fields (Abooso Goldfields Ltd)	302,847/8.6
Iduapriem/Teberbie	Anglogold Ashanti	243,533/6.9
Bibiani	Anglogold Ashanti	212,716/6
Bogoso/Prestea	Golden Star Resources	174,315/4.9
Obotan	Resolute	95,000/2.7

Source: MBendi 2005.

Recent reinvestment and rehabilitation of bauxite and manganese mining operations and proposed privatization of the State diamond mining company suggested that the mining sector would be a significant component of the economy for at least the next decade. Although still in early development stages, the development of offshore natural gas resources and completion of the West African Gas Pipeline will be key long-term factors in supplying the energy needed to support increased development in Ghana, which will reduce dependency on high-cost petroleum imports and erratic hydroelectric power supply (Coakley 2002).

In many places worldwide the environmental legacy of mining has been or is perceived to result in blighted communities, environmental damage, and altered landscapes. NGGL intends to demonstrate that by applying good practices at a greenfield site, it is possible to operate a modern gold mine which will benefit neighboring communities. Poor perceptions of mining do exist in communities in Ghana; although much of this perception is the result of population influx seeking jobs and artisanal mining. NGGL recognizes that community aspirations and perceptions will need to be addressed such that people will not misrepresent the impact of the project just because it is a gold mine.

PROJECT DESCRIPTION

The Ahafo South Project area is located approximately 300 km northwest of the capital city, Accra, 107 km northwest of Kumasi, and 40 km south of the regional capital of Sunyani. NGGL's life-of-mine plan for the Ahafo South Project involves development of four mine pits to produce and process approximately 7.5 Mt of ore annually over a 15-year period. Current resources are estimated at 105 Mt of ore producing 6.8 million ounces of gold. Initial development (Project area) involves approximately 2,174 hectares (ha) for construction and operation of the following facilities and mine components:

- Four open-cut mine pits (Amama, Subika, Awonsu, and Apensu)
- Waste rock disposal facilities
- Mill and processing plant
- Water storage facility (dam and reservoir) to provide water for processing plant
- Tailing storage facility (dam and impoundment)

- Environmental control dams and other storm water and sediment control structures
- Ancillary facilities (resettlement sites, bypass roads, accommodation camps, and mine services).

Open pits (Amama, Subika, Awonsu, and Apensu) will be developed and supply ore during the initial phase, after which additional deposits to the northeast are planned for development during subsequent phases. Surface disturbance associated with mine components is shown on **Figure 2-2** and summarized in **Table 2-2**.

SITE PREPARATION

Site preparation includes removal of merchantable timber, clearing, grubbing, construction of access roads, and salvaging growth media for future use in reclamation. A Construction Camp to house workers is among the initial projects currently under construction. A bypass road is also under construction around the Kenyase 1 and 2 Townships to accommodate deliveries of equipment and supplies to the mine site without traveling through Kenyase village. Road width will be 8.5 m including shoulders. The Kenyase-Ntotoroso road will be realigned for approximately 5.2 km south of the processing plant site.

MINE PITS

The Ahafo South Project involves removal of ore and waste rock from four open pit mines identified as Amama, Subika, Awonsu, and Apensu. Ore and waste rock will be drilled and blasted in sequential benches to facilitate loading and hauling. Blasted ore and waste rock will be loaded into off-road, end-dump haul trucks using shovels and front-end loaders. Within each mine, benches will be established at approximately 6-m vertical intervals with bench widths varying to include safety berms and haul roads. Haul trucks will move within the pit(s) using roads on the surface of benches with ramps extending between two or more benches. A 500-m buffer zone will be established around the perimeter of mine pits as a safety barrier for fly rock produced during blasting.

The Amama pit will be mined to a depth of 144 m and disturb approximately 36 ha; Awonsu pit is designed to be excavated to an overall depth of 140 m and disturb approximately 52 ha; Apensu will be mined to a depth of 285 m with surface disturbance of 74 ha; and Subika pit will be mined to a depth of 270 m disturbing 88 ha. Ore and waste rock production for each mine are shown in **Table 2-3**.

Groundwater inflow into each pit will be routed to a collection sump and pumped to the tailing storage facility or water storage facility for eventual use as makeup water in the process plant and mill.

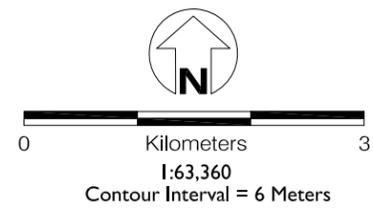
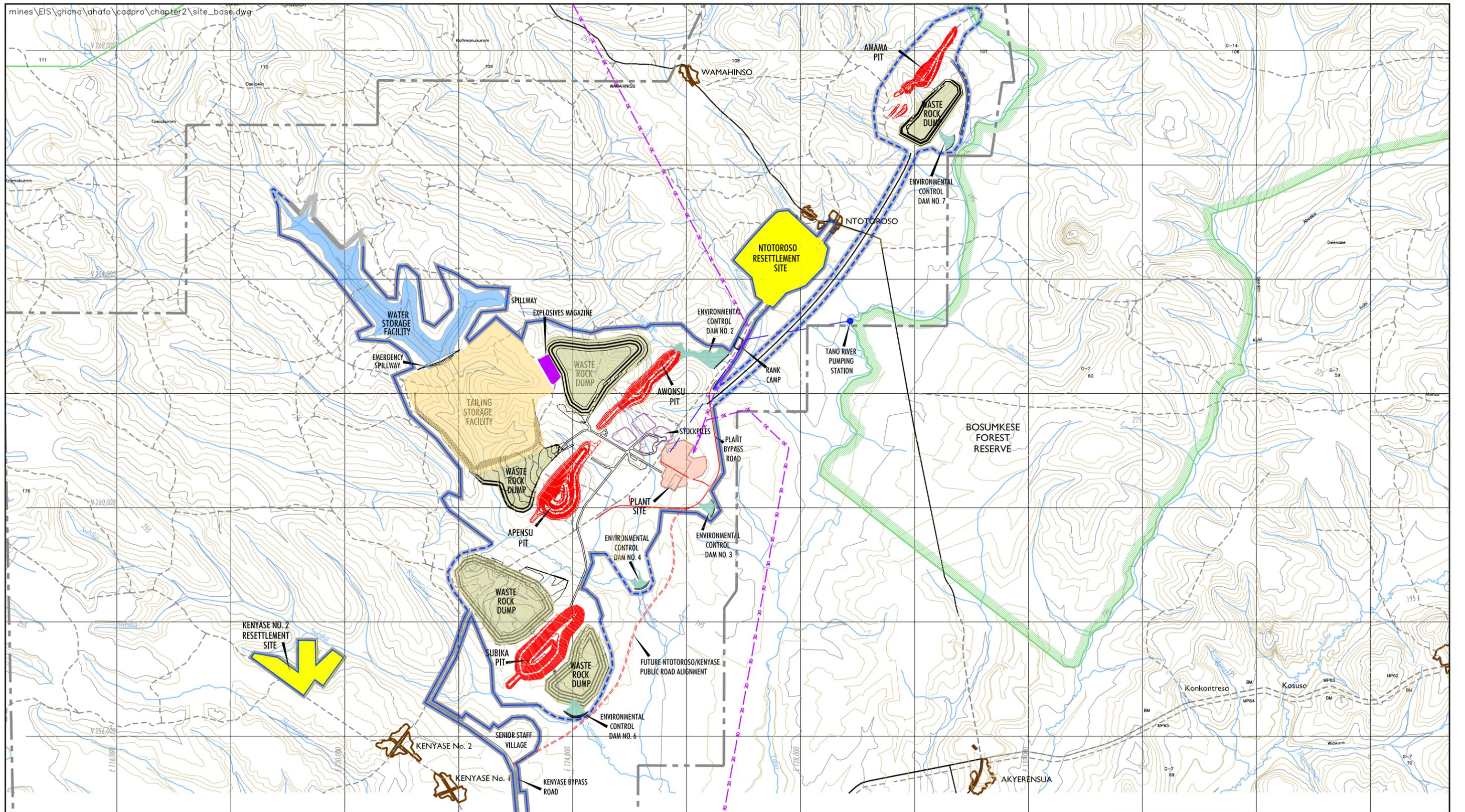

- Existing Primary Road
- - - Existing Secondary Road
- Proposed Haul Road
- Forest Reserve Boundary
- Pipeline
- VRA Overhead Powerline
- Lease Boundary
- Project Area
- Project Area Undetermined

Mine and Facility Site Plan
 Ahafo South Project
 Brong Ahafo Region, Ghana
 FIGURE 2-2

TABLE 2-2	
Surface Disturbance by Mine Component	
Ahafo South Project	
Mine Component	Hectares
Mine Pits¹	
Amama	36
Apensu	74
Awonsu	52
Subika	88
Subtotal	250
Waste Rock Disposal Facilities	
Amama	73
Apensu	93
Awonsu	165
Subika (east)	97
Subika (west)	179
Subtotal	607
Major Infrastructure	
Tailing Storage Facility	460
Water Storage Facility	280
Sediment Control Dams	49
Subtotal	789
Ancillary Facilities	
Process Plant/Mill	28
Mine Services Area (administration, vehicle maintenance, fuel station, laboratory, first aid clinic)	16
Pipeline Corridor to Tano River	8
Construction Laydown Area	7
Run-of-Mine Ore Stockpile Area	60
Explosive Magazine	9
Subtotal	128
Support Infrastructure	
Operations Village	22
Construction Camp – Senior Staff	10
Construction Camp – Junior Staff	2
Security Camp	1
Subtotal	35
Roads	
Haul Road – Amama Pit to Process Plant	40
Kenyase Bypass Road	20
Kenyase – Ntoroso Road	60
Subika – Haul Road	15
Access Roads to tailing storage facility and Water Storage Dam	5
Subtotal	140
Resettlement Villages	
Ntoroso Resettlement Area	161
Kenyase OLA Resettlement Area	64
Subtotal	225
TOTAL DISTURBANCE	2,174

¹ Pit blast safety buffer zone not included.
Source: SGS 2004a.

WASTE ROCK DISPOSAL FACILITIES

Development of the Ahafo South Project will require construction of five waste rock disposal facilities within 60 to 100 m of each mine pit. Subika mine will have two waste rock disposal facilities located to the east and west of the pit. Waste rock disposal facilities have been engineered for stability and designed, where practicable, with boundaries to blend with surrounding topography. The design static safety factor is 1.3 and the pseudo-static safety factor is 1.0. Overall height of waste rock disposal facilities will range up to 100 m above existing ground levels. Slopes of waste rock disposal facilities will be graded to 3.0H:1.0V.

Mine Pit	Ore (tonnes)	Gold (ounces)	Waste Rock (tonnes)	Total Tonnes	Strip Ratio Waste/Ore (tonnes)
Amama	12,020,779	711,948	23,242,237	35,263,016	1.93
Apensu	34,776,966	2,436,336	135,219,697	169,996,663	3.89
Awonsu	24,113,445	1,242,701	35,057,423	59,170,868	1.45
Subika	34,690,358	2,461,787	166,558,957	210,249,315	4.80
Total	105,601,548	6,852,772	360,078,314	465,679,862	3.41 avg.

Source: SGS 2004a.

Waste rock will be placed by end-dumping down an advancing face in successive horizontal lifts of 18 m. Ditches will be constructed around the base, sides, and upslope position to divert surface water runoff away from the area. Waste rock disposal facilities will be constructed on a base of compacted, low permeability materials designed to prevent vertical migration of fluids and sloped to allow drainage to an environmental control dam. The low permeability base will be constructed incrementally as waste rock placement proceeds. French drains will be constructed to allow for flow from streams and seeps that will be covered by the waste rock disposal facility. French drains will be constructed of minimum 300 mm diameter (acid-neutralizing) waste rock, a non-woven geotextile fabric placed over the rock, covered with 600 mm of low permeability materials and compacted to a maximum design permeability of 1×10^{-6} centimeters per second (cm/sec).

Based on current data, potentially acid generating (PAG) waste rock would not be encountered at the Ahafo South Project. However, if kinetic testing of waste rock to confirm static tests indicates a potential for acid generation the following procedures would be implemented to manage PAG material:

- (PAG waste rock will be encapsulated within the waste rock disposal facilities. The toe of sulfide (PAG) material is placed back from the perimeter limits of the ultimate footprint of the waste rock disposal site to allow placement of an outer cover of acid-neutralizing waste rock. Due to size sorting which occurs during end-dump construction, the low permeability base would be overlain by the coarsest material within the next lift. This layer provides a preferred flow path for water migrating downward through the waste rock disposal facility, and promotes lateral flow along the low permeability base. This system limits water from contacting the PAG waste rock for extended periods of time.

- Surface drainage upslope of the base perimeter of the waste rock disposal facility would be diverted with ditches to prevent run-on to the disposal facility. During construction, a minimum 1 percent gradient would be maintained on lift surfaces to reduce infiltration. Surface compaction from haul trucks and dozer traffic would help minimize infiltration of water into the rock piles.
- A low permeability cap would be constructed on the final lift of PAG material. The cap would be constructed of random wheel compacted clay or alluvium to provide a barrier to limit infiltration fluid migration and thereby reduce the volume of acid rock drainage. The low permeability cap would be 600 mm thick and sloped to promote runoff, further reducing potential for water to contact PAG waste rock. The cap would be covered with 600 mm of growth medium and designed so regrading during final reclamation would not breach the cap.

Inspection of the waste rock disposal facilities would be performed quarterly, and following heavy precipitation, to detect abnormal conditions, anticipate remedial actions, and ensure integrity of ditches, berms, and collection ponds.

Waste rock geochemistry and potential for generation of acid mine drainage is discussed in Chapter 4 – *Geology and Minerals*.

TAILING STORAGE FACILITY

The tailing storage facility will be constructed in the Subri stream drainage as cross-valley storage between two embankments (north and south) as shown on **Figure 2-2**. The northern upstream embankment will also serve as the downstream dam for a water storage facility. The tailing storage facility was designed by Knight Piésold Consultants (Knight Piésold 2003) and independently reviewed by Chlumsky Armbrust & Meyer (CAM) (2005). The tailing storage facility will be state-of-the-art using rotational, subareal tailing deposition and designed, constructed, and operated in accordance with Newmont's Standards for Tailing Management and relevant sections of the Ghana Minerals and Mining Law, 1986, Ghana Mining Environmental Guidelines, Final Draft, 1994; State of Nevada (U.S.) Administrative Code Chapter 445A, which governs design, construction, operation and closure of mining facilities; and IFC Operational Policy 4.37. The tailing storage facility will be operated as a "zero-discharge" facility, with all water returned for use in the ore processing circuit, and no water discharged to the environment. The entire tailing storage facility will be fenced to prevent access by fauna and domestic livestock. The perimeter fence will be patrolled round-the-clock to ensure security is maintained. Measures that will be used by NGGL to manage cyanide in the tailing storage facility are described in this chapter under the Cyanide Management and Treatment Program under the *Process Plant* section.

The tailing storage facility site is located within a low seismic hazard zone, with expected peak ground acceleration for events having a 10 percent chance of exceedance in 50 years of between 0.4 m/s² and 0.8 m/s². Seismic accelerations experienced at Ahafo from the most significant event (4.4 March 1997 227 km from site) would have been a peak of 9mm/s² (based on Esteva and Rosenblueth method). The selected design peak horizontal ground acceleration adopted for the tailing storage facility is 0.1 g (Lycopodium 2003).

Construction and Seepage Control

Minimizing seepage from the tailing storage facility is important from a number of water management goals, including:

- Minimizing risk of contaminating surface and or groundwater resources by degraded water seepage from the impoundment or from leakage from the impoundment into the underdrain system.
- Maximizing return of water to the plant facility for reuse in ore processing.
- Maximizing settled density of tailing by dewatering.

In order to accomplish these goals, several seepage control features would be incorporated into preparation of the drainage basin and the tailing storage facility design. These include seepage control both in the form of low permeability layers, cut off trenches, and two sets of underdrain collection systems described below. The constructed tailing storage facility is described from bottom to top.

1. Initially, the tailing basin would be prepared for construction by salvaging timber, clearing and grubbing the surface of vegetation, and stripping and stockpiling topsoil. Throughout most of the basin, this would typically leave a surface of moderate (about 20 m over 1.5 km) relief composed of saprolite (weathered in place bedrock consisting predominantly of clay and quartz) that ranges from 5 to 40 m thick. The upper surface of the saprolite (0.5 metres) would be scarified and compacted.
2. In some parts of the basin, a natural drainage network exists consisting of fluvial channels filled with higher transmissivity sand and gravel. Throughout the tailing basin, this drainage network of alluvial materials would be trenched to a depth of approximately one meter and a system of interconnected slotted drain pipe covered with a geotextile fabric sock would be placed in the filter-fabric lined trenches, and backfilled with sand. This network of pipes (part of Leachate Collection and Recovery System, LCRS) would flow to a High Density Polyethylene (HDPE) lined collection basin or sump constructed in sand near the upstream end of the southern tailing embankment (**Figure 2-3**) in the LCRS piping system along the main Subri stream drainage. Drainage in pipes beneath the southern embankment joins about 400 m downstream to a common sump, with pump-back capabilities.
3. Cut off trenches would be excavated to extend across the full width of the upstream side of the southern embankment and the downstream side of the northern embankment. These trenches would be excavated through alluvial materials (if present) into the underlying saprolitic foundation materials (at least 1 to 5 m deep depending on location). The trenches would contain slotted drain pipe and would be backfilled with sand. The trench along the upstream side of the southern embankment would drain laterally to the low spot formed by the LCRS collection basin or sump.
4. The cut off trench along the southern embankment would be constructed in lifts along with the embankment until it intersects the bottom of the HDPE liner on the upstream face of the embankment. Both north and south embankments will have underdrain systems beneath them comprised of a series of finger drains that run parallel to the Subri drainage and extend the full width of the embankments. The cut off trench along the lower side of the northern embankment would have a system of drainpipes installed that would collect seepage from beneath the northern embankment (water storage dam) and direct it laterally to a low point in elevation.

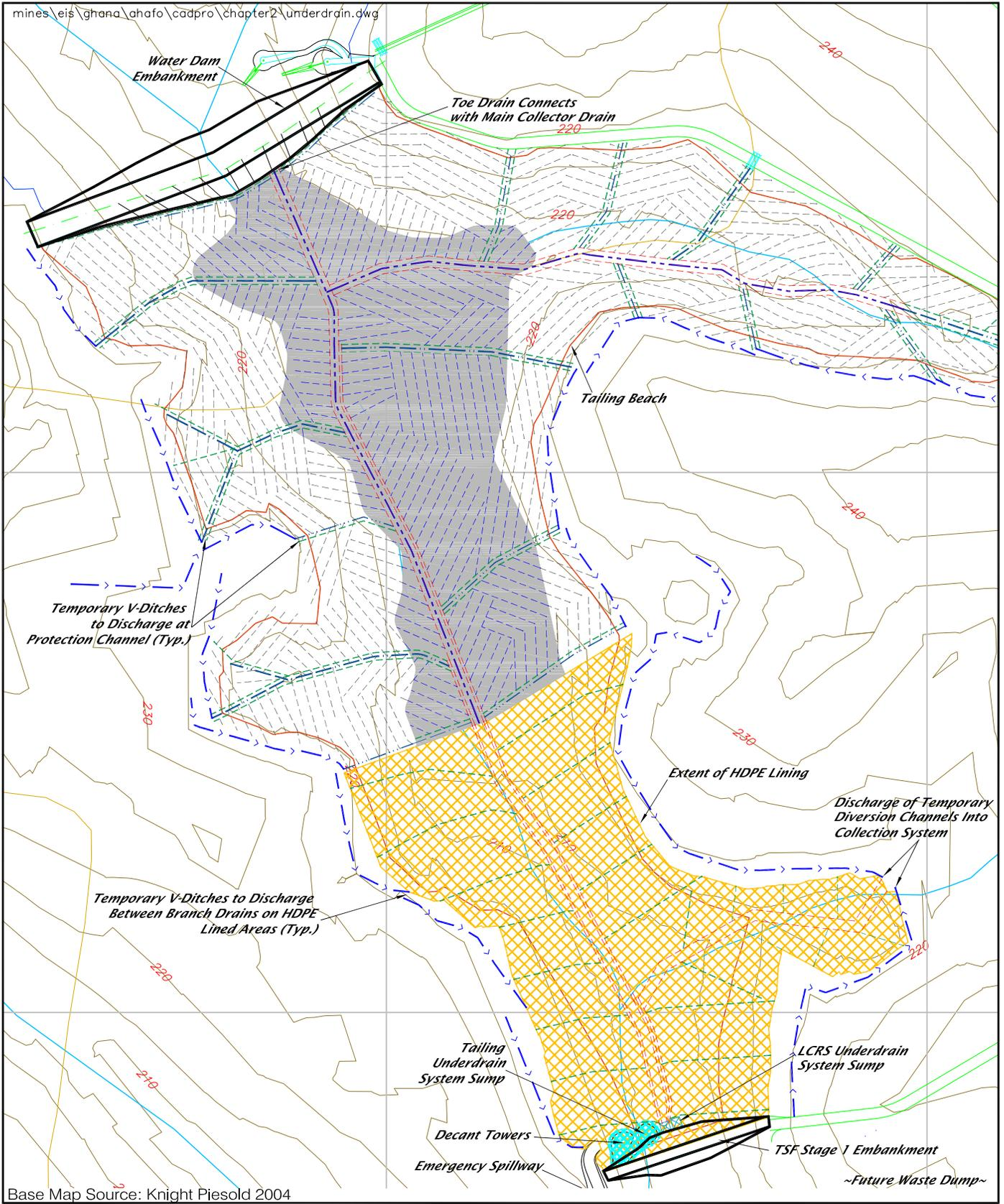

Base Map Source: Knight Piesold 2004



- 1.5mm (60mil) Smooth HDPE Geomembrane Liner Extent
- 1.5mm (60mil) Double Side Textured VFPE/LLDPE Geomembrane Liner
- Compacted Soil Liner Areas with Finger Drains
- Finger Drain
- Branch Drain
- Collector Drain
- Temporary Diversion Channel

Tailing Underdrain Layout
Ahaf South Project
Brong Ahafo Region, Ghana
FIGURE 2-3

The main (south) embankment will be constructed in stages using low permeability materials salvaged from the Apensu mine pit (**Figure 2-4**). Stage 1 of the south embankment will be constructed to a height of 217 mRL to provide 15.7 Mt of storage capacity during the first 24 months of operation. Subsequent stages will be constructed using mine waste rock from Apensu mine pit to attain an ultimate height of 241.7 mRL to provide a total storage capacity of 88 Mt of tailing material. In later years, the south embankment will be buttressed by the Apensu waste rock disposal facility.

The north embankment of the tailing storage facility, which also forms the dam of the water storage facility, will be constructed in stages similar to the south embankment. Subsequent stages will be constructed using waste rock from the Apensu mine pit to an ultimate height of 251.8 mRL.

Embankments will have an in place recomacted coefficient of permeability of not more than 1×10^{-6} cm/sec. Stability of the south embankment was assessed under both static and pseudo-static conditions for a number of possible failure modes. Results indicate a static factor of safety of 2.81 for all raises on the upstream slope of the south embankment (1.63 pseudo-static).

5. The downstream collection basin or sump for the LCRS underdrain system would have a HDPE riser pipe, lying along the upstream face of the embankment, from the sump to the embankment crest. This riser pipe will provide pump-back capabilities for the LCRS underdrain system. Solution could be pumped back to either the supernatant tailing pond or the plant facility.
6. Within the tailing storage facility basin proper a low permeability soil liner would be placed and compacted over the prepared basin substrate and LCRS underdrain system. The soil liner would be compacted to attain a minimum permeability of 10^{-8} meters/second (m/sec). This would be accomplished either by scarifying and compacting the upper 0.5 m of the saprolytic material or by placement of two 150 mm layers of imported material each compacted to meet the required permeability. In the center of the valley and along larger tributaries, a low permeability soil liner would be constructed over alluvial sand and gravel deposits of the LCRS.
7. The upstream face of the south embankment and the uppermost end of the tailing storage facility basin will be lined with a 1.5 mm textured VFPE/LLPE liner. The textured liner would transition laterally (be welded to) to a 1.5 mm smooth HDPE liner a short distance north of the southern embankment. The smooth HDPE liner would cover an area large enough to reduce seepage from the supernatant pond. The size of this area is large enough to contain not only water from the processing decant wastes, but also meteoric precipitation from a 1 in 100 year wet or 100 year/24 hour storm event superposed on average annual rainfall conditions. The liner will be installed in stages as the tailing storage facility is constructed. The HDPE liner will be installed over material compacted to a maximum design permeability of 1×10^{-6} cm/sec.

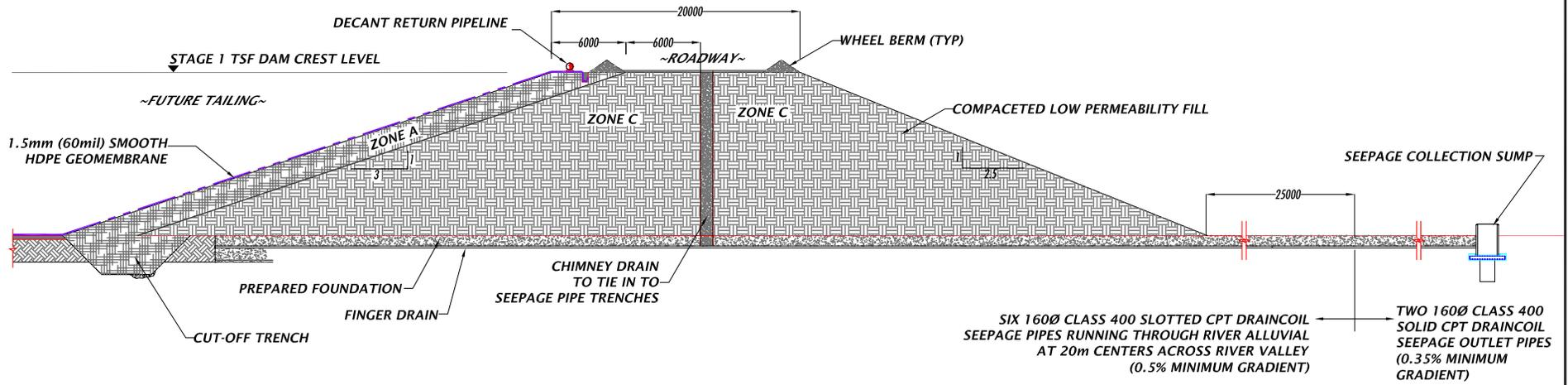

SOUTH EMBANKMENT TYPICAL SECTION

Scale 1:500

South Embankment Section
Ahafo South Project
Brong Ahafo Region, Ghana
FIGURE 2-4

The tailing storage facility underdrain collection system would be constructed in stages over either the HDPE liner or the compacted soil layers throughout the entire basin area. The underdrain system would be designed to reduce the phreatic surface on the tailing basin and the area immediately upstream of the embankment. The design of the underdrain system optimizes the natural north-to-south slope across the impoundment area (about 18 m of relief). The tailing storage facility underdrain system would consist of two drainage networks: the main collector drains and branch drains. Details concerning the layout of the tailing impoundment underdrain and relevant sections and details are shown on **Figure 2-3**. The collector and branch drains would be constructed over the compacted soil or HDPE liner. Drains would consist of draincoil pipe embedded in a sand layer. The smaller branch drains feed to larger diameter branch drains, which in turn feed to main collector drains, which flows directly into the collection sump located at the upstream toe of the southern embankment. Main collector drain coil pipe would be wrapped with geotextile and placed in 200 mm deep trenches surrounded with sand (**Figure 2-5**).

8. The tailing storage facility would be designed to contain storm events of return period up to 1 in 100 years. In the event a storm exceeding the design event occurs, discharge from the facility would be controlled via an emergency spillway. The emergency spillway would be designed to handle storm events of average recurrence interval of 1 in 1,000 years. New spillways would be constructed with each successive lift of embankment. The spillway constructed at closure of the facility would be designed to control discharge resulting from a probable maximum precipitation storm event.

Tailing will be pumped from the processing plant to the facility via an overland HDPE and steel pipeline. The pipeline will be contained within a bermed trench lined with 1.5 mm textured HDPE liner. The pipeline is designed so that the contents will drain either to the tailing storage facility or to a lined event pond near the plant site should an accidental release occur.

Tailing deposition will be by the sub-aerial technique whereby tailing is pumped from a perimeter pipeline along the east side of the tailing storage facility to encourage formation of beaches over which the slurry flows in a non-turbulent manner towards a supernatant pond at the southern end of the facility. Deposition of tailing is carried out on a cyclical basis with tailing deposited over an area until a predetermined thickness is established. Deposition then moves to an adjacent area to allow previously deposited layers to dry and consolidate. Over time, a tailing beach will develop that slopes away from the deposition zones towards the supernatant pond. Water will be pumped from the supernatant pond by use of a series of pump out decant towers.

Operation of the tailing storage facility will be in accordance with NGGL's 5-Star tailing storage facility Performance Standard. Operational monitoring, performance, and stability of the facility will include the following programs:

- Tonnes of solids pumped to tailing storage facility;
- Water volume (m³) to the tailing storage facility;
- Precipitation and evaporation at the tailing storage facility;
- Amount of return water from the tailing storage facility; and
- Collection efficiency of the underdrain system based on sump pump monitoring;

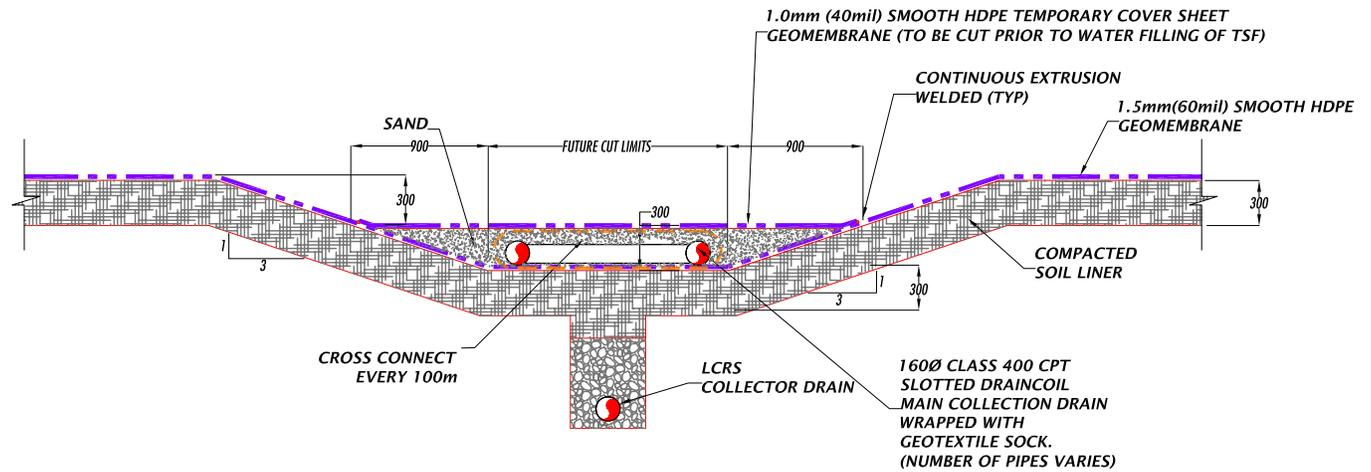

**TYPICAL MAIN COLLECTOR DRAIN ON
GEOMEMBRANE LINER AREAS**

Scale 1:50

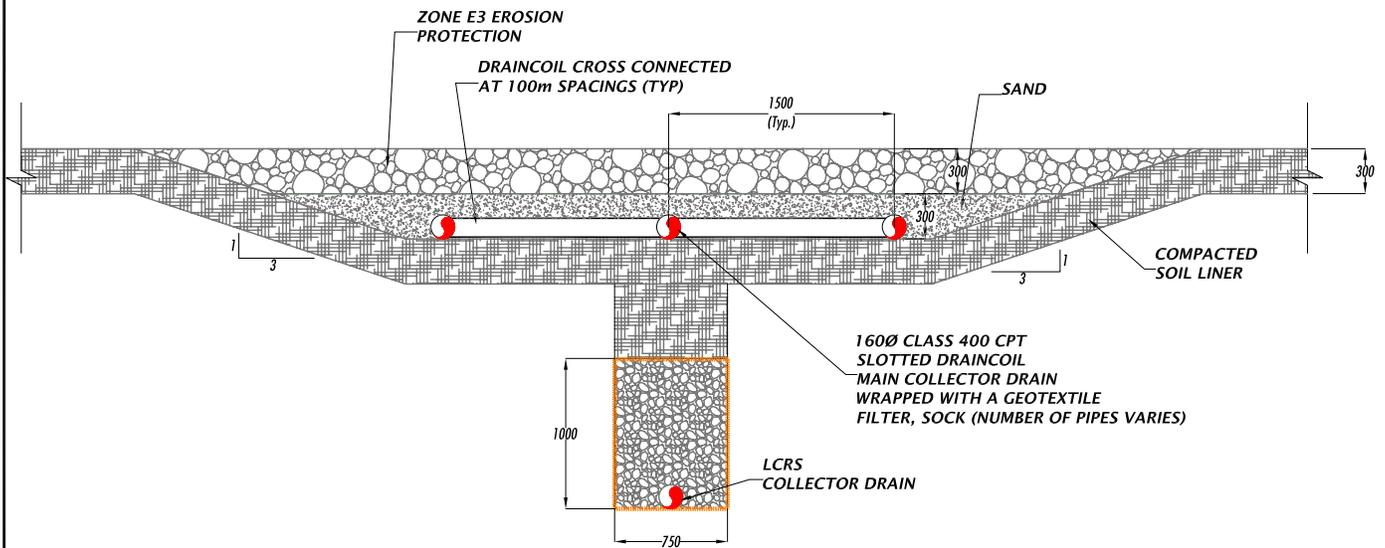

**TYPICAL MAIN COLLECTOR DRAIN ON
SOIL LINER AREAS**

Scale 1:50

Source: Knight Piesold 2004

- Concentration of WAD cyanide in the supernatant pond; and
- Monitor tailing moisture content, density, and survey of tailing beach and supernatant pond will be performed quarterly.

One groundwater monitoring well will be installed upgradient and five wells will be installed downgradient of the tailing storage facility. Frequency and duration of the monitoring program will be developed with the Ghanaian EPA.

Mill tailing composition and chemistry are discussed in *Geology and Minerals* section of Chapter 4.

WATER STORAGE FACILITY

The water storage facility dam is a cross-valley embankment, which forms the north embankment of the tailing storage facility, and creates the dam for the water reservoir on the northwest flank. The water storage facility was designed by Knight Piésold Consultants (Knight Piésold 2003) and independently reviewed by Chlumsky Armbrust & Meyer (CAM) (2005). The water storage facility will impound water from a 28-km² area of the Subri stream watershed. At full capacity the reservoir will extend about 5 km northwest to southeast, flood approximately 128 hectares, and provide 6 million cubic meters (Mm³) of water for mine processing operations.

The crest of the dam will be constructed to an elevation of 231.5 m RL with an overflow spillway at 226.5 m RL. Full pool elevation of 225 m RL will provide 6 Mm³ of water for processing operations. Freeboard of 1.5 m will provide capacity to contain a 100-year storm event estimated to produce 2.55 Mm³ of water flowing into the facility. An emergency spillway will be constructed at the south end of the north embankment at an elevation of 226.5 m RL. An additional spillway will be constructed in the northernmost extension of the reservoir at elevation 226.5 m RL and direct flow into the Awonsu drainage and ultimately into Environmental Control Dam #2. The spillway will be designed to control discharge resulting from a Probable Maximum Precipitation storm event.

The water storage facility is scheduled for completion 17 months prior to commissioning the process plant. This will allow adequate time to accumulate a sufficient quantity of water to accommodate ore processing activities. However, withdrawal from the Tano River will be considered should drought conditions occur that preclude accumulation of an adequate water supply. Withdrawal of water will only occur during one wet season (April to November) and would remove approximately 2 to 18 percent of river flow, depending on base flow conditions. The pump station and pipeline corridor will be located within the mine lease area as shown on **Figure 2-2**.

SURFACE WATER CONTROL DITCHES

Surface water control ditches will be constructed as necessary to intercept and divert potential run-on water from flowing into mine pits, tailing storage facility, or onto waste rock disposal facilities and ore stockpiles. These channels will divert uncontaminated run-on water back into natural drainage down gradient from disturbed areas or into environmental control dams. Surface water control ditches have been designed and constructed to accommodate a 100-year, 24-hour precipitation event. Target release criteria for the sediment control system are 50 milligrams per liter (mg/l) total suspended solids (TSS).

ENVIRONMENTAL CONTROL DAMS

Five environmental control dams have been designed for the Ahafo South Project area. One of these dams for the Bosumkese pit area is in design stage and will be located to maximize retention of surface water runoff and seepage from the waste rock disposal facility. These dams perform an integral function in the storm water management plan. These dams will be located to collect sediment and runoff from construction and mining activities. Impounded water will be used in dust suppression and as makeup water in the ore processing circuits. Environmental control dams have been designed and constructed to accommodate a 10-year, 24-hour precipitation event. Locations of environmental control dams are shown on **Figure 2-2** and summarized in **Table 2-4**.

Water may be periodically discharged from the water storage facility and/or environmental control dams if quality meets applicable standards and is approved by the Ghanaian EPA. NGGL intends to incorporate a risk based approach for water discharges, with wide approval from Ghana EPA, which considers beneficial use of water in the affected drainages. Target release criteria for the environmental control dams are 50 mg/l total suspended solids (TSS).

PROCESS PLANT

The process plant is nominally designed to process an average of 7.5 Mt annually consisting of a blend of both run-of-mine (ROM) primary and oxide ore. The Ahafo process plant would treat a blend of oxide and primary ores during the initial period of operation. Oxide reserves would be exhausted by about year three after which only primary ore would be processed. Physical characteristics of Ahafo ore, presence of free milling gold, and metallurgical test work have been used to develop an ore processing plant flow-sheet design. This design has been simplified for illustrative purposes on **Figure 2-6**.

Run-of-Mine (ROM) ore would be hauled by truck from the open-pit mines and placed on the ROM ore storage pad or directly into the ROM hopper. ROM and oxide ore would be blended in the mill feed to optimize process plant throughput. Dust suppression sprays and dry dust collection systems would be installed on the respective crushing circuits and all ore transfer points.

Ore would feed directly from the ROM hopper into a single stage primary crusher. Crushed material would be transported by conveyor to the semi-autogenous grinding (SAG) mill. The ground material would then pass through a vibrating screen to separate material larger than 10 mm in diameter; this material would be transferred to a cone crusher for further size reduction and returned to the grinding circuit. From there crushed ore is moved through a closed circuit system of hydrocyclones where it is sized, and if necessary through a ball mill, where it is re-ground into finer material (80% <75 μ). Lime and water are added during the grinding process.

Two outlets from the hydrocyclone distribution system have the ability to supply ore slurry, known to contain free milling gold, directly into a centrifugal gravity gold recovery circuits. Each circuit incorporates a feed preparation screen and gravity concentrator. Gravity concentrate would be transferred to a storage cone and then periodically transferred to the batch intensive cyanidation reactor using a centrifugal pump.

mines\eis\ghana\ahafo\cadpro\chapter2\flow.dwg

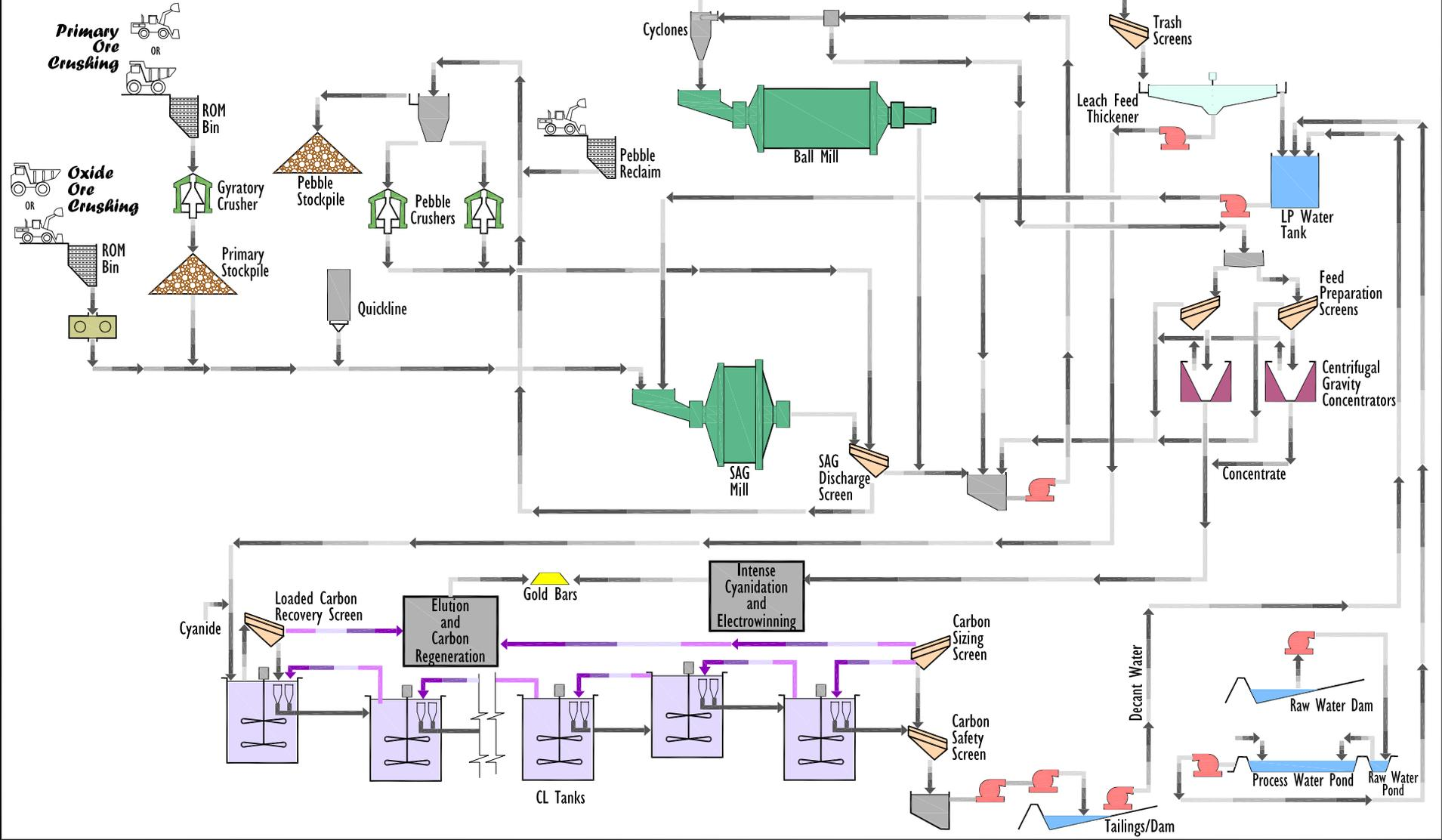

-  Pump
-  Cyanide
-  Carbon

Process Flow Diagram
Ahafo South Project
Brong Ahafo Region, Ghana
FIGURE 2-6

Site	Height (meters)	Basin Area (hectares)	Basin Volume (meters ³)	Drainage Area (hectares)
ECD-2	3.0	19	131,000	3,000
ECD-3	3.0	2.4	26,500	140
ECD-5	4.5	21	223,000	3,371
ECD-6	3.0	6	80,000	297

Note: Revised mine operations have eliminated ECDs numbers 1 and 4. ECD-7 located downgradient of the Bosumkese waste rock disposal facility is in design stage so no sizing information is currently available.

Source: SGS 2004a.

Ore slurry from the hydrocyclones would be transferred through leach feed thickener tanks into the Carbon in Leach (CIL) circuit (**Figure 2-7**). The CIL circuit consists of eleven interconnected tanks each with a capacity of approximately 3,250 m³. Thickened slurry would gravity flow through the series of tanks. Lime, to control pH of the slurry, would be introduced with the main thickened slurry inflow and by additions to the first few tanks. Cyanide to dissolve the gold would be manually added to the first few tanks in the circuit. Fresh, regenerated carbon that adsorbs dissolved gold would enter the circuit at the last CIL stage tank and be pumped counter-current to the slurry flow. A pump would be used to transfer slurry and gold-laden carbon from the CIL tanks to a loaded carbon recovery screen. The washed loaded carbon would gravitate to the stripping plant near the gold recovery room. Discharge from the last CIL stage would flow to the tailing tank and onto the tailing storage facility after final screening for remaining carbon.

The CIL tanks would be constructed on concrete ring beams in a self-contained area with a sloping concrete floor. Any spillage from the circuit would flow to one of four sumps located on the periphery of the containment area and would be pumped back to the processing circuit or to the carbon safety screens for disposal to tailing. A 7,000 m³ event pond would be provided to contain overflow from containment areas within the process plant (milling, thickening, CIL, and tailing). Overflow from containment areas would be directed to the event pond via drainage channels. Two sump pumps located in the event pond would return water collected to either the tailing tank or the processing circuit.

Activated carbon impregnated with gold, would be periodically removed from the circuits and transferred to the stripping/refining facility, where gold is separated from the carbon. Barren process solution, the solution resulting after adsorption of gold onto carbon containing lime and cyanide, is recycled back into the process system.

Treatment Plant - Area Under 24 Hours Security

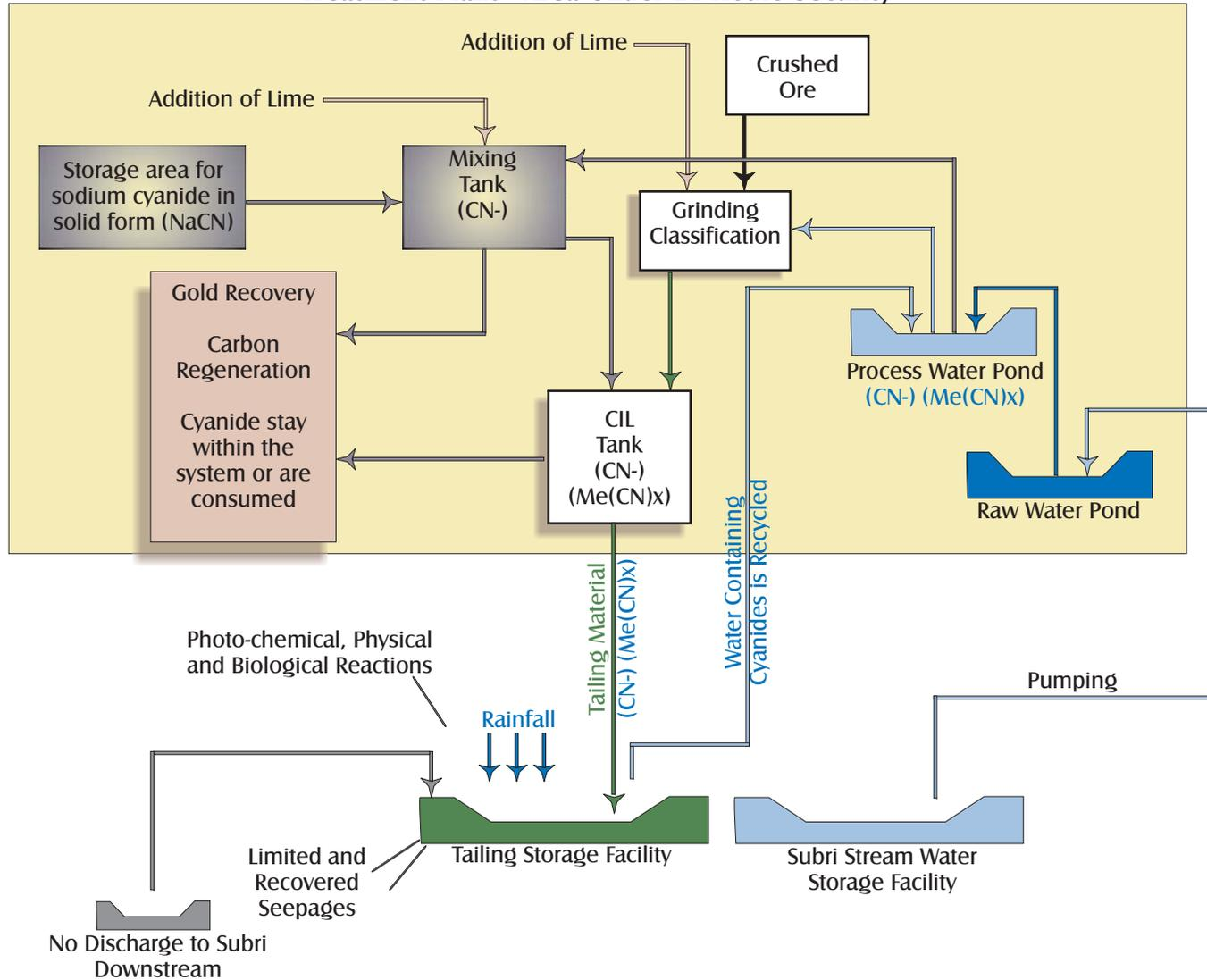

Carbon-in-leach Circuit
Ahafo South Project
Brong Ahafo Region, Ghana
FIGURE 2-7

The gold room recovery and refining facility consists of an acid wash carbon-stripping circuit, electrowinning circuits, and carbon regeneration kilns. Gold contained in the gold-bearing solution (electrolyte) resulting from acid wash stripping the activated carbon is transferred to electrowinning cells, where a direct current is passed through stainless steel anodes and stainless steel mesh cathodes cause the gold in solution to plate onto the cathodes. The cathodes are washed with high-pressure spray water and the gold slime recovered in a frame filter press. The gold sludge filter material is then dried in ovens and direct smelted with fluxes in a diesel-fired furnace to produce doré bars. The barren carbon would be transferred to a carbon regeneration kiln circuit for reuse.

The stripping and gold room areas would normally operate 7 days per week. The gold room design is based on full security surveillance by a security guard and a second level of surveillance by remote control closed-circuit cameras with remote viewing and recording facilities.

All process piping within the grinding, CIL, and gold recovery circuits would be constructed above ground to facilitate frequent inspections. All processing piping will be positioned on racks above a concrete-lined trough to provide secondary containment. Flanges will be located and positioned with a shield to direct any pressurized release into the concrete-lined trough.

Once initial operations are underway and water begins to accumulate in the tailing impoundment, process water would be principally obtained from tailing decant return and run-off from within the tailing facility. Makeup water required for milling process could also be provided from the fresh (raw) water storage pond (7,000 m³) or from a process water pond used to temporarily store process water. The process water pond would be a HDPE double-lined 15,000 m³ facility with a leak detection system.

Permanent cyanide destruction facilities have not been incorporated into the process plant design. Experience at other Ghanaian operations indicates free and weak acid dissociable (WAD) cyanide levels are usually less than 50 mg/l in supernatant ponds of tailing storage facilities. Photo-degradation of cyanide and tight process controls would likely ensure levels of cyanide in the supernatant tailing pond are maintained at this level. However, NGGL has developed a cyanide management and treatment program to validate this assumption and demonstrate its social responsibility commitment to protect workers, community, and the environment.

Cyanide Management and Treatment Program

NGGL cyanide management practices are largely derived from the International Cyanide Management Code (ICMC) discussed in *Chapter 1*. All aspects of the ICMC will be implemented at the Ahafo South Project. Cyanide related facilities will be managed in such a manner as to protect workers, the community, and the environment including primary environmental receptors of air, water (surface water and groundwater), soil, and flora.

The process plant and tailing storage facility will be constructed and operated to minimize cyanide use to the extent possible, thereby limiting concentrations of cyanide in the mill tailing and process solution ponds. All facilities will be operated to protect birds, other wildlife and livestock from adverse effects of cyanide process solutions.

A concentration of 50 mg/l WAD cyanide or lower in solution is typically viewed as being protective of most wildlife and livestock. This is a generalization and NGGL will undertake a risk assessment to ascertain cyanide mortality on wildlife and livestock. NGGL will evaluate and manage additional risks due to metal-cyanide complexes (e.g., copper cyanide complex) to be protective of human health and the environment.

NGGL has identified the following activities to validate current designs and expected tailing cyanide concentrations to meet stated objectives to protect wildlife prior to commissioning ore processing operations:

- Determine the expected range of WAD Cyanide concentration at point of discharge into the tailing facility;
- Model decay of cyanide from point of discharge across tailing beach and in the decant pond;
- Investigate and perform cost analysis for Cyanide Recycle and Cyanide Destruct to meet generally accepted WAD CN point of discharge levels (i.e., 50 mg/L or level protective of wildlife);
- Perform a bird survey of the mine environment to determine species and flight paths in the vicinity of the mine;
- Perform scientific literature survey to assess the impact of modeled cyanide levels on identified site specific bird species;
- Perform Risk Analysis using data collected;
- Implement measures identified from the risk assessment to ensure protection of avian species;
- Collate wildlife list from fauna surveys that are adjacent to the mining operations;
- Identify species that could gain access to the tailing facility;
- Identify the necessary controls to ensure the identified wildlife do not gain access to the tailing storage facility; and
- Implement process plant control measures (recycle or destruct) to ensure protection of human health and the environment and implement prior to start-up.

NGGL will regularly monitor WAD Cyanide levels (and other specific metal-cyanide levels as required) in all solution ponds that contain cyanide. Additionally, NGGL will minimize access of wildlife and livestock to solution ponds with a WAD Cyanide concentration equal to or less than that identified by the risk assessment. In some instances it may be found that WAD cyanide levels greater than 50 mg/L may be protective of wildlife, however, this situation requires thorough investigation and review. NGGL will implement further measures (i.e., fencing with round-the-clock surveillance, filling collection ditches with gravel, and covering or netting solution in ponds and impoundments, or treatment of tailing solutions) to restrict access by wildlife and livestock. Such measures would be implemented for the entire tailing storage facility to be protective of workers, the community and the environment including primary environmental receptors of air, water (surface water and groundwater), soil, and flora.

To ensure that any short term increase in cyanide levels in the supernatant pond (caused by a processing plant problem) can be lowered to less than the 50 mg/l target, facilities for destruction of cyanide using hydrogen peroxide in a mobile emergency cyanide destruction facility would be available.

NGGL will conduct a site-specific risk assessment to determine the level of risk posed by the design and operation of the Ahafo South Project. Should results of that risk assessment identify the need to install a cyanide detoxification circuit, NGGL will install the circuit and operate it as necessary to manage the risk.

ROADS

Site Access Roads

A new road will be constructed around the Kenyase Township to connect with the Kenyase – Ntotoroso Road. The main purpose of the road is to divert Project traffic from travel through Kenyase 1 and 2 to provide safe access for equipment and supplies to the Ahafo South Project area. The road will be 7 m wide with 1.5 m shoulders and finished with a two coat, stone chipped bitumen seal. Culverts will be placed at appropriate locations. The Kenyase Bypass Road is shown on **Figure 2-2**.

The Kenyase – Ntotoroso Road will be upgraded and eventually realigned around the Ahafo South Processing Plant. The interim alignment will extend 5.9 km from the intersection with the Kenyase Bypass Road to the Operations Village and will provide construction vehicle access to the Project site. The road will be widened to 7 m and existing culverts extended to accommodate a wider road and finished with a two-coat, stone-chipped bitumen seal.

The Interim Kenyase – Ntotoroso Road will be realigned south of Subika from a point near the Senior Staff Village and extend 5.2 km to the processing plant. The road will be 7 m wide with 1.5 m shoulders and finished with a two coat, stone chipped bitumen seal. All new roads will have continuous v-drains with level spreaders at approximately 200 m intervals to retain sediment and reduce stormwater flow velocities.

Haul Roads

Haul roads developed in the Ahafo South Project Area will be 30-meters wide (running width) to safely accommodate haul truck traffic with a maximum grade of 10 percent. Haul roads will be maintained on a continuous basis to ensure safe, efficient haulage operations and to minimize fugitive dust emissions. Haul roads will be constructed using in-situ material; however, oxide or neutral mine waste rock may be used, as necessary, for construction or routine maintenance. Access roads will be constructed to an average width of 6-meters using in-situ materials and waste rock similar to haul roads. All roads will be constructed with adequate drainage controls and best management practices to minimize sediment impacts to the local environment.

Mine roads would be private with restricted access enforced through mine security. Hazard potential would likely increase due to increased traffic delivering materials and equipment during the construction phase. Mine roads within the Project area include:

- Haul roads designed for use by 120-ton haul trucks; and
- Access roads designed for use by light vehicles.

CONCURRENT RECLAMATION

NGGL has been conducting concurrent reclamation at the Ahafo South Project area addressing disturbances resulting from exploration activities. Disturbances include exploration roads, drill pads, trenches, sumps, and other land disturbances within the Project area. As various facilities reach the end of their period of use, NGGL will initiate reclamation activities concurrent with exploration and mining operations.

ANCILLARY FACILITIES

Ancillary facilities at the Ahafo South Project will include an equipment fueling and maintenance area, topsoil stockpiles, explosives magazine, mine services area, utilities, worker accommodation, and storm water control facilities. The mine services area will be located immediately south of the plant site and include the administration office, security post, first aid clinic, heavy equipment workshop, light vehicle workshop, tire shop, wash down bay, mine services water services, refueling station, and mine control facilities. Locations of ancillary facilities are shown on **Figure 2-2**.

ACCOMMODATIONS

Expatriate and senior Ghanaian staff will be provided with housing. Junior staff will be provided a housing allowance with which to obtain rented accommodation in Kenyase or Ntotoroso. Accommodation facilities in the Ahafo South Project area will include:

- Construction camps;
- Security camp; and
- Operations village.

The first contractors on site will be camp construction and earthmoving contractors. These contractors will likely rent accommodation in local villages for their workforce. The owner's construction management team will be temporarily housed at the Rank camp until the construction camp becomes available.

Construction Camps

The construction senior staff camp will be located adjacent to the plant area and will accommodate senior construction staff expatriates and senior Ghanaian supervisors. The total number of employees is estimated to be approximately 300.

The construction junior staff camp will also be located adjacent to the plant area and will house all non-local Ghanaian construction personnel. The number of employees of this type is estimated between 320 and 600 and construction of this accommodation will be staged to meet progressive buildup of personnel.

Security Camp

The security camp will be located on the operations village access road, approximately 1 km from the village and will house 160 security personnel.

Operations Village

The operations village will be located approximately 5.5 km northwest of the treatment plant. Access to the operations village will be from the Kenyase Bypass. Accommodation will consist of 35 three-bedroom units supported by various recreational and other facilities.

EXPLOSIVES MAGAZINE

An explosives magazine will be located between the tailing storage facility and the Awonsu waste rock disposal facility and constructed with adequate containment, drainage, and environmental controls to prevent accidental release of materials to the environment. The site will be fenced, bermed, lighted with 24 hour security and operated in accordance with Explosive Regulation 1970, L.I. 666.

MEDICAL UNIT

A 240 m² clinic will be constructed as part of the construction senior staff camp and retained through the life-of-mine. The medical/first aid clinic will be located adjacent to the administration building. The medical clinic will provide emergency first-aid and medical treatment for workers at the Project site. The medical unit will also distribute first-aid kits and supplies to the plant and workshops. An ambulance will also be acquired for use at the mine site.

GENERAL AND MINE ADMINISTRATION

A 1,481 m² general administration building will be constructed adjacent to the process plant. The structure will be provided with potable water, electricity, and amenities connected to a package sewage treatment plant. Offices for mine equipment maintenance contractors will be provided at the mine workshop.

PLANT WORKSHOP, WAREHOUSE, AND ADMINISTRATION

The 307 m² plant workshop, warehouse, and administration building will be located within the treatment plant security area. Facilities will include electrical and machine shop, tools, rigger store, and receiving area.

Solid non-hazardous waste generated from the plant workshop would be disposed in a landfill constructed within the waste rock disposal facility. An incinerator capable of generating temperatures over 1000°C would be used to process any organic liquid, medical waste, solvents, and paint.

LABORATORY

A 542 m² minerals assay laboratory will be constructed in the general administration area. Facilities will include:

- Sample preparation area for mill and grade control;
- Offices;
- Metallurgical laboratory;
- Environmental laboratory;
- Fire assay area;
- Balance room;
- Wet chemical laboratory;
- Chemical store;
- Lunch room and toilets; and
- Chemical store.

ELECTRICAL POWER

Electricity for the Ahafo South Project will be provided by the Volta River Authority (VRA) from 161kV substations at Kumasi and Sunyani via an overhead power line connected ring circuit. Current existing electrical infrastructure is located to the north of the Project area along the route from Kumasi to the northwest to Techiman and southwest to Sunyani. The VRA has previously identified the need to complete an additional power line from Kumasi to Sunyani to provide improved power reliability to large population centers (i.e., Sunyani) and establish the grid suitability for northern expansion. VRA identified a planned route from Kumasi directly to Sunyani which would allow the completion of a ring circuit to improve reliability to the northern region and meet the needs of the grid infrastructure for future northern expansion. VRA's planned Kumasi-Sunyani route was identified in 1999 as part of the overall strategic electrical infrastructure plan for Ghana.

Development of the Ahafo Project will provide VRA with sufficient near-term customer base to enable financing for completion of the previously planned ring circuit project. The length of the Kumasi to Sunyani power line will be approximately 150 km, with an estimated installed electrical load of 47 MW with a predicted peak continuous load of 35.98 MW. Consultants sponsored by NGGL will support VRA's efforts by providing engineering, procurement, logistical support, and help VRA arrange financing.

VRA will be responsible for line route survey, Environmental Impact Assessment (EIA), right-of-way compensation, and land acquisition associated with the proposed 161 kV power line route (VRA 2004). Portions of the power line right-of-way which pass through the Project area will be collectively evaluated by both the VRA and NGGL related to compensation and land acquisition related issues to

ensure consistent standards are applied. Power line right-of-way located outside the Project area will be directly managed by the VRA according to Ghanaian regulations.

Construction of the VRA power line is considered an “associated facility” to development of Ahafo South Project. Forest Reserve and compensation issues associated with alignment of the power line are in compliance with IFC policies. NGGL and IFC have received a commitment from VRA that the line is being planned in accordance with World Bank Group Policies. Discussions with the VRA and the Ghanaian Forestry Commission indicate there would be no significant degradation of critical natural habitat in areas of forest reserve through which the power line passes. VRA will also implement a consultation program and Resettlement Action Plan covering compensation to people affected by the power line.

SECURITY

The security camp accommodation will be a 10-person barrack style building (412 m²) with basic recreational facilities. Four levels of security will be employed across the site:

1. **Low-level security** will consist of manned security huts and boom gates to control vehicle access to the mine area.
2. **Medium level security** will consist of security fencing around key project infrastructure with security huts, boom gates and turnstiles to control vehicle and personnel access. Areas encompassed by medium security include the mine workshop, facilities, and administration buildings.
3. **High-level security** will be comprised of a double security fence, with digital closed-circuit cameras to monitor the treatment plant and associated facilities. Access will be limited to plant personnel via the main security and change house facility.
4. **Maximum security** will include an additional security fence, manned security room, electronic access, and digital CCTV cameras to monitor the gold room building. Access will be limited to gold room personnel and senior management only.

FIRE SERVICES

Water for fire suppression will be obtained from the raw water pond at the plant site. A diesel driven pump will start automatically on loss of raw water pressure to provide a secure fire service to the plant area, mine service area, and accommodation villages.

EMPLOYMENT

Construction of the Project is scheduled to occur over a 29-month period and employ approximately 1,500 people, including 300 expatriates and 1,200 nationals. The anticipated workforce once mining operations begin will total about 620 permanent Ghanaian workers and approximately 40 expatriates. An additional 350 contractors will augment this workforce to provide security, laboratory, vehicle and equipment maintenance, catering, and transport services.

RECRUITMENT

Recruitment of employees for the Ahafo South Project will focus on providing employment opportunities for local area residents. Except for positions requiring special qualifications and/or experience, employment of qualified applicants will be by the following order of priority:

- Current Project employees;
- Villages within 5 km of Project (e.g., Kenyase 1, Kenyase 2, Ntotoroso, Gyedu, & Wamahinso);
- Brong Ahafo Region; and
- Ghana.

NGGL anticipates in excess of 20,000 applicants for a limited number of positions; 17,000 applications have been received for the construction phase. The recruitment and selection process will commence 18 months prior to commissioning the process plant. NGGL policy dictates that unskilled labor will be recruited from within the area of mine development. Construction contractors will be required to source locally.

TRAINING AND DEVELOPMENT

In response to the need of recruiting a skilled labor force NGGL has developed training programs that prepare local residents to compete for available skilled positions. The area has a farming based economy with limited regional industry and a shortage of skilled labor in available in the concession area. NGGL recognizes that importation of required skill levels will likely have a disruptive effect on local communities resulting in undesirable social and economic pressures.

Training and development programs will consist of the following key features:

- Maximizing local area employment opportunities will be a major objective. The definition of “local” will be determined during consultation with local chiefs;
- Selection process will require trainees to be local with a minimum 9 years schooling and will target 18 to 26 year olds. Testing will assess cognitive ability, mechanical aptitude, mathematical ability, and language comprehension;
- A centralized competency based training system that provides training needs assessment, training and development programs targeted at job requirements and formal certification and accreditation;
- Appropriate training workshop and classroom facilities and required equipment and training aids. The facility will be used for training in all areas, including safety and loss prevention, supervisory and management training, general training such as computer software, clerical, and warehousing.

NGGL anticipates this approach will have cost and efficiency implications, particularly at start-up, but is considered essential to achieve our social responsibility commitment. In the long-term maximizing the use of local labor resources will reduce administration costs and reduce allowances related to relocation, accommodation, and transport.

EXTERNAL AFFAIRS MANAGEMENT

NGGL, as a subsidiary of Newmont Mining Corporation, will develop and operate the Ahafo South Project under the Newmont Corporate Social Responsibility Policy and Five Star Management System, which includes management systems and discipline specific standards on Community and External Relations (Newmont 2003).

Each year, the operation will be assessed against the above standards and the management systems standard by external social assessors. As such, the Ahafo Project will operate in full compliance with all applicable Ghanaian regulations pertaining to its local stakeholders. Furthermore, in recognition of the evolving state of the regulatory structure in Ghana, and in recognition of ever-increasing requirements from shareholders and financial institutions, the facility will operate in accordance with generally accepted International Standards and Practices that relate to social issues. Consideration of these objectives will be included in planning and implementation of all aspects of the operation.

Management and employees will be informed of responsibilities to external stakeholders through training and supervision. All levels of development and operation will consider the needs and interests of local stakeholders in the decision process. Through awareness of social responsibility and cooperation from employees, Newmont will develop and maintain our social responsibility in Ghana.

In accordance with Five Star Management System requirements, periodic auditing and reviews will be conducted by internal/external auditors to verify environmental conformance and confirm management responsibilities are in accordance with External Affairs procedures.

EXTERNAL RELATIONS MANAGEMENT STRUCTURE

The General Manager will be responsible for compliance with Ghanaian and corporate social responsibility requirements, including general oversight of the operations commitments to its external stakeholders. The Manager for External Affairs will report directly to the General Manager and be responsible for the development and overseeing the implementation of procedures and programs for community relations, local NGO relations, community development, communications and land access required for the Ahafo Project to ensure an integrated approach to these issues that result in long term sustainable positive outcomes.

Reporting to the Manager for External Affairs will be the Community Relations Superintendent, the new Community Development Superintendent, and Communications Officer. Several Community Relations officers, data technician and clerks support the Community Relations function. The Community Development function will be support by several community development offices. The Communications Office will be supported by the regional Communications Manager, who is based in Accra. The External Affairs department will also be supported by the regional Land Access Manager. The external affairs management structure of NGGL is shown in **Figure 2-8**.

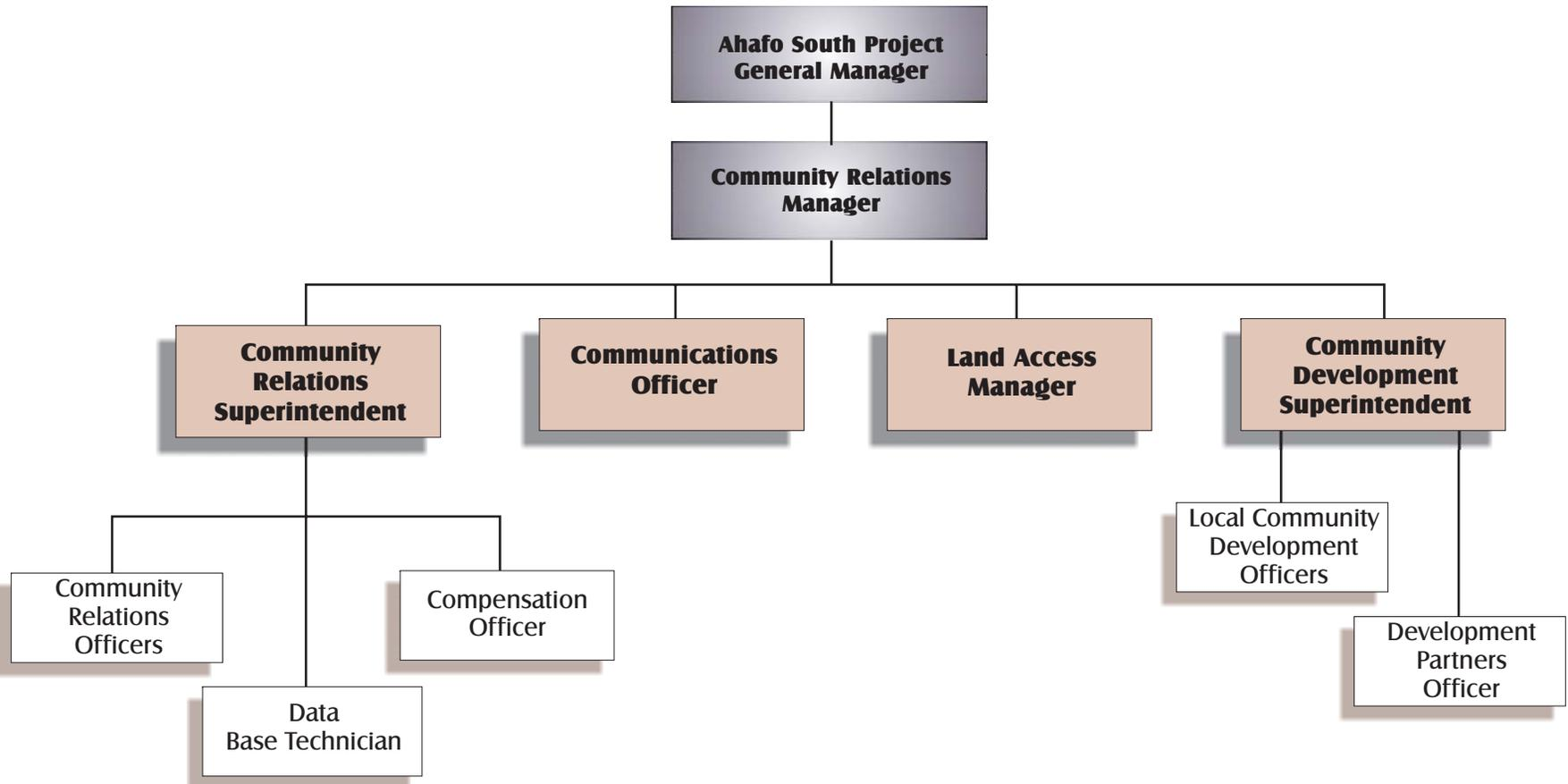

Organizational Chart for External Affairs Department
Ahafo South Project
Brong Ahafo Region, Ghana
FIGURE 2-8

ENVIRONMENTAL MANAGEMENT

NGGL will develop and operate the Ahafo South Project under the Newmont Corporate Environmental Policy and Five Star Management System (see Chapter 1) as standard operating procedure. Key elements of the system include:

- Recognition that sound environmental management is essential to successfully operate the facility.
- Accountability of all staff for minimizing environmental risk and assuring compliance with regulatory requirements as well as Newmont Corporate environmental objectives.
- Implementation of monitoring programs to provide early warning of any deficiency or unanticipated performance in environmental safeguards.
- Training and orientation of employees in order to perform their jobs in compliance with sound environmental practices.

Consideration of environmental factors to be included in all new or modified facilities and in the purchase of equipment and material by Newmont.

- An environmental incident reporting system would be established and reports prepared in a timely fashion.
- Environmental response planning would be completed to provide the basis for response to environmental incidents, including spill prevention and counter measure plans, monitoring plans, and mitigation plans.
- Periodic reviews would be conducted to verify environmental performance and to continuously strive towards improvement.
- Procedures would be implemented to assure ongoing dialogue with government entities in connection with regulatory changes, which may affect the operation.

ENVIRONMENTAL MANAGEMENT STRUCTURE

The General Manager will be responsible for compliance with Ghanaian and corporate environmental requirements. Each Department manager will be accountable for maintaining their respective areas of responsibility to comply with applicable environmental standards. The Environmental Manager will support the operations management team and be responsible for directing and maintaining compliance with Ghanaian laws and Corporate Policy, implementing environmental monitoring programs, providing training support to Project staff with regards to environmental responsibility, and interfacing with governmental authorities concerning environmental issues.

Each employee will be responsible for compliance with environmental policy as it pertains to their respective work assignments. The Ahafo Environmental Manager would report directly to the Ahafo General Manager. The Environmental Manager would also report to the Director of Environmental Affairs – Africa.

The Environmental Department will provide personnel tasked to support the Communications Manager and Community Relations Department when dealing with local communities on environmental issues. The environmental management structure of NGGL is shown in **Figure 2-9**.

ENVIRONMENTAL MANAGEMENT FOCUS AREAS

RESOURCE MONITORING

Air Quality

Fugitive dust emissions will be controlled through use of direct water application, chemical binders or wetting agents, and revegetation of disturbed areas concurrent with operations. All ore transfer points in the processing plant will have water sprayer units. Dust deposit gauges and volumetric sampling methods will provide specific information appropriate to assess health and safety issues.

After completion of the elution process, the barren carbon will be transferred to a 900 kg/hr regeneration kiln circuit. Carbon will be heated to 650-750°C and maintained for 15 minutes to allow effective regeneration to occur. Gaseous emissions from the carbon regeneration kiln will be scrubbed to remove volatilized heavy metals and toxic gases.

Water Resources

The purpose of hydrologic monitoring is to establish baseline data and report changing conditions as mining operations continue and expand in the area. Water quality, water table elevations, and/or flow rates are measured monthly, quarterly, or semi-annually at designated monitoring wells, springs/seeps, and surface water stations.

Water quality sampling sites will be located upstream and downstream of project facilities including water storage facility, tailing storage facility, and all drainages from mine pits, waste rock disposal facilities, stockpiles, and plant operations. Parameters such as, pH, conductivity, turbidity, suspended solids, oil and grease, total and fecal coliforms, nutrients, chemical oxygen demand, biological oxygen demand, cyanide, iron, manganese, aluminum, and arsenic will be regularly analyzed from collected samples.

WASTE MANAGEMENT

Several types of waste would be generated during construction and operation of the Ahafo South Project including: household waste, non-toxic industrial waste (tires, discarded metal parts and fittings, plastic packaging and containers), waste oil and filters, refinery slags and cupels (recycled into the milling circuit), and solid and liquid laboratory waste (acidic and aqueous solutions, solvents, crucibles, cupels, and slag). Waste disposal will be conducted in accordance with Ghanaian requirements and NGGL's waste disposal protocols.

NGGL will monitor waste generation and disposal conditions during construction, operation, and closure. Should conditions warrant NGGL will implement additional waste minimization, treatment, and disposal measures for hazardous, non-hazardous, and sewage waste beyond those currently identified.

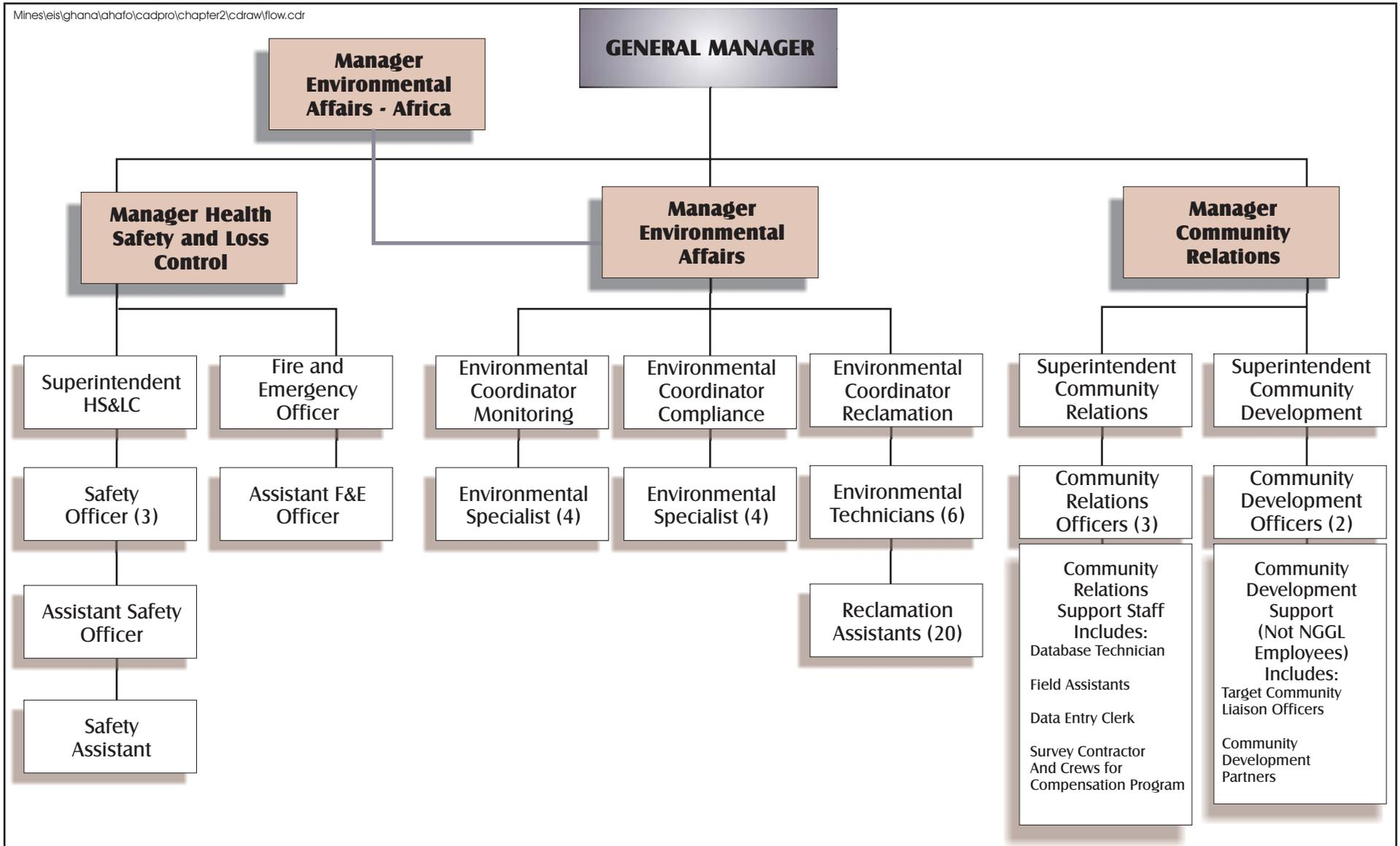

Environmental Management Structure
 Ahafo South Project
 Brong Ahafo Region, Ghana
 FIGURE 2-9

Hazardous Waste

There are currently no methods for disposal of hazardous waste in Ghana. The Ghanaian EPA is responsible for provision of guidelines for such wastes. A Draft Hazardous Waste Control bill is currently before the Cabinet for consideration. Bio-medical and other hazardous waste are currently managed through landfilling.

In response to a global mandate for environmentally sound management of hazardous waste, NGGL has embarked on a life cycle approach to address chemicals and other hazardous waste management in an integrated manner. This involves a broad range of stakeholder institutions and organizations including non-governmental organizations. NGGL is committed to working with the EPA to implement a comprehensive National Chemicals Management Profile. The profile was prepared by EPA with assistance from the United National Institute of Training and Research and the Inter-organization Programme for Sound Management of Chemicals.

NGGL has a waste minimization program to evaluate hazardous substances used on mine property. Where possible, alternative products that generate no waste or solid waste, rather than hazardous waste, would be used. Where feasible and practicable, NGGL will use citrus-based products in place of chlorinated solvents. All refrigerant will be non-CFC and compliant with U.S. EPA regulations. Assay laboratory waste (e.g., slag, crucibles, and cupules) will be processed through the mill process circuit and report to the tailing storage facility. An incinerator capable of generating temperatures over 1000° C will be used to process any organic liquid, medical waste, solvents, and paint.

Sewage Disposal

Packaged sewage treatment plants will be located at the construction senior staff camp, construction junior staff camp, and senior staff village. A permanent facility will service the construction senior staff camp, security barracks, and the plant. A separate plant will be constructed at the senior staff village. Capacity of the treatment plants will be 260 m³/day for the main plant and 80 m³/day for the operations village.

Treated effluent will be discharged to local drainages. This effluent will be monitored daily to ensure compliance with relevant discharge standards. Parameters will include pH, conductivity, turbidity, total suspended solids, chemical oxygen demand, biological oxygen demand, total and fecal coli forms, free chlorine, nitrates, and phosphates.

Solid Waste

Solid, non-hazardous waste (e.g., tires, lumber, concrete, and paper) will be disposed in a landfill constructed within a waste rock disposal facility. The specific disposal site on the waste rock disposal facility will change to coincide with area of active waste rock disposal facility. Wet waste from food processing facilities and medical waste from the clinic will be incinerated in a purpose-built incinerator constructed to meet U.S. EPA standards.

HAZARDOUS MATERIALS MANAGEMENT

NGGL has completed major hazard assessments for its existing operations worldwide. The assessments have been completed in recognition of specific mining practices, process chemical requirements, and site specific operational control programs.

Cyanide Use

NGGL is a signatory to *The International Cyanide Code for the Manufacture, Transport, and Use of Cyanide in the Production of Gold* (International Cyanide Management Code - ICMC). The ICMC is an industry voluntary program for gold mining companies and focuses on the safe management of cyanide and cyanidation mill tailing and leach solutions. The objective of the Code is to improve management of cyanide used in gold mining and assist in the protection of human health and reduction of environmental impacts. Refer to the *International Agreements, Policies, and Standards* section of Chapter I for more discussion of ICMC.

Major hazards inherent to the Ahafo South Project operations are primarily associated with cyanide transport, handling, and storage, and on-site spill prevention and control. NGGL has developed the following documents, which address major hazards inherent to site-specific mining activities and operations. The following documents will be revised and updated to identify site-specific parameters at the Ahafo Project during construction and start-up:

- Sodium Cyanide Transport Contingency Plan;
- Spill Prevention, Control and Response Plan; and
- Emergency Response Plan.

The following presents a brief overview of each document with respect to document contents, use, and implementation. All documents will be updated and utilized for construction and mine operation in the Ahafo Project area.

Sodium Cyanide Transport Contingency Plan

The Sodium Cyanide Transport Contingency Plan was developed and implemented in recognition of hazards and risks associated with transporting sodium cyanide and other hazardous materials from the port cities of Tema and/or Takoradi to the Ahafo South Project site.

The Plan establishes critical risks associated with the transport process based on route specific issues and provides support to carriers, suppliers, buyers, government entities, and the local population to minimize the consequences of an event during transport activities which may affect the health and safety of individuals, cause damage to the environment, or involve public installations and services.

The Sodium Cyanide Transport Contingency Plan is based on the following actions:

- **Prevention:** All contractors and carriers shall operate in accordance with U.S Code of Federal Regulations (CFR) 49 Rules, and the Loss Control Department of NGGL to establish an auditing system.

- **Response:** NGGL will provide an escort for each convoy transporting hazardous materials and in specific cases, where the substance is purchased FOB mine, provide an auditor during transport, until the material reaches the mine site. Each supplier will have its own Contingency Plan, developed in accordance with this plan and on contractual terms established by NGGL.
- **Coordination:** NGGL will establish a Security Communication Center to operate 24 hours per day, all year round, with an emergency dedicated line, to receive alarm calls and activate the plan.

An emergency Rapid Response System will be deployed for incidents involving hazardous materials owned by NGGL, and respond to emergencies occurring to convoys owned by third parties traveling to the Ahafo South Project site. The Rapid Response System will remain in effect until accepted by the authorities at the scene. Additional information and details concerning transport of hazardous materials in Ghana is contained in NGGL's *Mission and Policy with Respect to Contingencies for Material Transporting*.

The following components are included in the Sodium Cyanide Transport Contingency Plan:

- Plan Objectives;
- Characteristics of Sodium Cyanide or other hazardous material;
- Basic Emergency Equipment Requirements;
- Description of the Transport Route;
- Responsibilities of the Convoy Boss;
- Action Plan During Transport;
- NGGL Responsibilities; and
- Third Party Communications.

Emphasis of the Plan is to clearly establish training requirements, control points, emergency response actions, and notification procedures should an incident occur. All NGGL personnel, transport personnel, and assisting agencies are regularly trained to manage incidents related to the transport of sodium cyanide. The Plan provides additional details regarding specific actions.

Spill Prevention, Control and Response Plan

The Spill Prevention, Control and Response Plan (SPCR) was developed and implemented in recognition of hazards and risks associated with onsite activities related to cyanide handling, storage, other process reagents, fuels, and waste handling onsite. The Plan establishes critical risk areas, hazardous materials, and control measures. The following components are included in the SPCR Plan:

- Site and Facility Descriptions;
- Petroleum Products;

- Cyanide and Process Solutions;
- Warehouse Storage of Solvents and Chemicals;
- Sodium Hypochlorite;
- Other Chemicals and Reagents;
- Response to Explosions, Fires and Medical Emergencies;
- Personnel Training; and
- Implementation of SPCR Plan.

Emphasis of the plan is to clearly establish characteristics of onsite hazardous materials in relation to site specific conditions. The Plan also specifically details the most common hazards, handling procedures, emergency response requirements, and training requirements. All NGGL personnel handling or working with hazardous reagent handling are regularly trained to manage incidents related to the transport of sodium cyanide. The Plan provides additional details regarding specific actions.

EMERGENCY RESPONSE PLAN

The Emergency Response Plan was developed and implemented as a comprehensive document for management of incidents that may occur at the Ahafo South Project site. The Plan establishes critical aspects of incident management including notification, incident management, organization, and responsibilities. The Plan has been developed to compliment the Sodium Cyanide Transport Contingency Plan and the Spill Prevention, Control and Response Plan. The following components are included in the Emergency Response Plan:

- Important Telephone Numbers;
- Incident Management Activation/ Notification Process;
- Incident Management Organization;
- Emergency Response Organization;
- General Functions and Responsibilities;
- Action/Notification Levels;
- Organization Chart;
- Control and Command Centers;
- General Evacuation Procedures;

- Search and Rescue Procedures;
- Emergency Termination/Return To Work Procedures;
- Closure Procedures; and
- Equipment/Material Resource Requirements.

Emphasis of the plan is to establish incident management procedures, organization, and responsibilities for all emergency response actions. NGGL personnel are regularly trained to manage incidents using the Emergency Response Plan. The Plan provides additional details regarding specific actions.

DIESEL FUEL

Approximately 2 million liters of diesel fuel will be stored on-site in aboveground two storage tanks. A lined secondary spill containment basin will be constructed around bulk storage tanks to contain 110 percent of the volume of the largest tank. Secondary containment will meet Newmont's minimum permeability standard equivalent to untreated concrete. All ancillary piping will be constructed above ground to facilitate frequent inspections and rapid repair should an accidental release occur. NGGL personnel will be instructed in operation and maintenance of equipment to prevent discharge of oil and has developed a spill prevention and containment plan for the bulk storage area. Meteoric water that falls within the containment basin will be treated through an American Petroleum Institute (API) approved oil/water separator designed to meet applicable discharge criteria prior to release off site. The Spill Prevention, Control and Response Plan address releases of petroleum products.

REAGENTS

Reagents used in the beneficiation process include sodium cyanide, lime, sodium or potassium hydroxide, and hydrochloric acid. These chemicals will be stored according to the compatibility principle in a secure and contained area located within the plant site.

Sodium Cyanide

Sodium cyanide will be delivered to site in solid form via 18-ton isotainers. The isotainer will be directly connected to holding tanks and sparged with water to produce a liquid cyanide mixture of the desired concentration. The sparging process will effectively remove all cyanide from the isotainer. The cyanide storage tanks will be constructed with a concrete secondary containment structure situated away from any acidic substances in a secure area located within the plant perimeter. The secondary containment structure will be designed with sumps that will transfer meteoric water and/or spillage in case of an upset condition in the processing plant. All operation related to cyanide handling will be automated and under the supervision of a qualified person. A supply of hydrogen peroxide will be stored on-site for use in emergency destruction of cyanide spills.

Hydroxide

Hydroxide in solid form will be received in 25 kg bags, added manually to the caustic mixing tank and mixed with water to a 20 percent w/w concentration. Quicklime will be delivered in bulk 20 tonne road tankers and be pneumatically transferred into a 400-tonne storage silo. Quicklime is metered directly

onto the mill feed conveyor, for circuit pH control. Lime is added to process solutions to maintain a pH higher than 10 in all solutions containing cyanide to inhibit production of hydrocyanic acid. Hydrochloric acid will be delivered in 200 liter drums and transferred into a storage tank and diluted to a concentration of approximately 3 percent w/w concentration.

Caustic and Hydrochloric Acid

Caustic in solid form will be delivered in 1 tonne bulk bags and stored cement lined and covered reagent storage facility. Hydrochloric acid will be delivered in 200-litre drums or 1,000-litre intermediate bulk containers and will be transferred into a storage tank. Hydrochloric acid will be stored within a concrete bunded area next to the mixing tank. The bunded area will have a collection sump that will be routed to the tailing tank in case of a spill or to manage meteoric water.

Hydrogen Peroxide

Three 24 kl ISO containers will be stored on-site for use in emergency destruction of cyanide. A skid-mounted pump will be used to meter hydrogen peroxide at the required rate.

DISPOSAL

Hazardous materials will be disposed of in accordance with all applicable regulations. Used motor oil, coolant, and hydraulic oil will be recycled.

ENVIRONMENTAL CONTROL MEASURES

This section contains descriptions of standard operational environmental control measures, mitigation, and monitoring measures being implemented by NGGL for the Ahafo South Project.

MINING AND SURFACE DISTURBANCE MANAGEMENT

- All surface disturbance will be reclaimed in accordance with applicable Ghanaian regulations and Newmont's Standards for closure and reclamation of mining facilities.
- Deforestation and land clearance in advance of soil salvage and mining operations will be limited to the extent practicable and will be conducted only on an as-needed basis.
- Concurrent reclamation will be conducted during operations to the extent practicable to control sediment and erosion and return the land to a beneficial use.
- Suitable growth media will be salvaged from disturbance areas. Soil material would be stockpiled for future use or direct hauled to regraded areas and paved in preparation of final surface reclamation.
- Regraded areas will be ripped and scarified to reduce soil compaction. Previously salvaged growth media would be placed to a minimum depth as required supporting plant community development over regraded areas, finishing graded, fertilized, and seeded.

- A noxious weed monitoring and control plan will be developed to ensure that reclaimed areas are protected from noxious weed invasion.
- Roads no longer needed for reclamation and access in the mine areas will be ripped scarified to reduce soil compaction, graded, covered with salvaged growth media and recontoured to blend with the surrounding terrain. The surface would be left in a roughened condition and seeded during the first appropriate season to promote vegetation success.
- Exploration roads, drill pads, sumps, and trenches will be reclaimed in conjunction with on-going operations. Exploration roads would be constructed by stripping growth media and using it as a safety berm at the edge of the exploration road. Material in the berm would be redistributed back onto the regraded surface during reclamation.

FOREST RESERVES

- Development of the Ahafo North Project and its relation to the Ahafo South Project may potentially affect the Bosumkese Forest Reserve. Existing permits (Ghana EPA 2001) allow construction of a haul road corridor across the Bosumkese Forest Reserve. Development of the haul road corridor, or other facilities which may affect forest reserves, would not occur prior to completion of detailed baseline studies and impact assessments designed to accurately depict existing biodiversity conditions within the forest reserves, assess potential impacts, and identify management practices and mitigation measures.
- NGGL is currently developing a Biodiversity Management Program for its Ghanaian operations. NGGL is committed to implement the Biodiversity Management Program for any future activity that may affect forest reserves.
- NGGL has committed to replanting an area equal to that disturbed by construction of the Volta River Authority 161 kV distribution line through forest reserve areas at a 3 to 1 ratio. Location of areas to be planted would be determined through coordination with appropriate government agencies.

SEDIMENT CONTROL

- All activities resulting in disturbance (exploration, construction, operations, and reclamation) will be conducted in accordance with the project sediment control guidelines. No intrusive activity will be conducted without prior approval of a site- or project-specific Construction Management Plan, which defines specific environmental impacts associated with the activity and specific Best Management Practices, environmental, and engineering control measures that will be used to minimize the impact.
- Run-on berms will be constructed around active mine panels to prevent surface water from entering work areas. Four Environmental Control Dams would be constructed in the Project area to collect, settle, infiltrate, and evaporate run-on/run-off water from areas disturbed by mining operations.
- Stormwater will be controlled using material handling procedures that minimize exposure of materials to stormwater; spill prevention and response measures; sediment and erosion control; and physical stormwater controls.

- Various BMPs such as brush barriers, temporary sediment ponds, small check dams, and sediment fences will be placed around all potential sediment sources such as stockpiles, waste dumps, and new construction areas as temporary erosion control measures until vegetation is established to provide stable soil conditions.

NOISE AND VIBRATION

- Blasting times will be made known to the public to avoid surprise effects. Sign boards will be located in Ntotoroso, Gyedu, Kawkuadekrom, Kenyase 1, and Kentase 2. Blasting will be performed only during daylight hours.
- Use of controlled blasting technology which could include initiation of the blast holes through bottom primers and non electric delay detonators connected with shock tubes on the surface (blasting relays), establishment of a maximum instantaneous charge.
- A noise monitoring program will be implemented to ensure that noise from activities and equipment at mine facilities meet or fall below the noise guidelines established by the GEPA at the nearest residential uses to the mine site.
- Establishment of a safe blasting perimeter of 500 m around all blasting sites.
- Blasting demonstration will be organized for public witnessing under the close supervision of the Ghanaian EPA and the relevant governmental and traditional authorities.

AIR QUALITY

- Fugitive dust emissions will be controlled through use of direct water application, chemical binders or wetting agents, and revegetation of disturbed areas concurrent with operations.
- Adverse effects of dust on crops and other vegetation will be controlled by keeping the road surfaces wet or by paving.
- Speed limits for project vehicles have been lowered through populated areas to minimize fugitive dust generation.
- Dust suppression sprays and dry dust collection systems will be installed on respective ore crushing circuits and all ore transfer points in the processing Plant.
- Gaseous emissions would be minimized through proper operation and maintenance of equipment.

FLORA AND FAUNA

- Administrative controls including policies that prohibit employees and contractors from engaging in hunting activities on all mine properties have been implemented. Conservation education programs for local communities and the employee population can be implemented through various NGOs currently focused on reduction of bushmeat dependency in Ghana.

WATER QUALITY

- Waste rock disposal facility drainage will be monitored and waste rock samples will be tested to assure the rock is non-acid forming and to determine possible metals that could be leached. If necessary, appropriate preventative measures such as encapsulation or water treatment will be considered.
- Water quality will be monitored in sediment control ponds and all mine water management structures prior to discharge. No discharge will be permitted that is not in compliance with applicable water quality discharge standards.
- Water quality and flow will be monitored in the Subri and Awonsu streams; no settlements will be developed below the tailing storage facility within the mining concession boundary.
- Emergency backup and treatment systems have been designed and procedures developed and implemented to control potential spillage of process effluent and other chemicals used on-site; NGGL will maintain a supply of calcium hypochlorite for detoxification of cyanide; all workshops will have a sloping concrete floor and runoff directed to degreasers prior to discharge.
- Best management practices will be used to minimize erosion from disturbed areas, including clearing land only when necessary and during the dry season, early revegetation, placing silt fences, brush barriers and grass bundles, constructing ditches and settling ponds, and protecting vegetation along drainage channels. Best management practices and other sediment and erosion control practices are defined in the Ahafo Project Sediment Control Guidelines.
- Earth berms will be installed around the perimeter of mine pits to prevent surface water runoff from entering the pits from upslope areas.
- Groundwater monitoring will be conducted surrounding the tailing storage facility and waste rock disposal facilities to assure that adverse impacts do not occur. Pump-back wells are planned around the tailing storage facility to be installed during the construction phase as an added measure of safety in case of potential accidental impacts to groundwater.

CHEMICAL MANAGEMENT

Typical reagents required for operation of the processing plant include: sodium cyanide, lime, caustic, hydrochloric acid, activated carbon, and flocculent. Spills or incorrect use could result in injuries to workers. NGGL's training of mine workers includes the proper handling, use, storage, transport, cleanup, and disposal of chemical reagents used for processing ore at the Ahafo South Project.

RECLAMATION AND CLOSURE PLAN

A draft reclamation plan (Plan) has been prepared by MFG, Inc. (2005) for the Ahafo South Project. The Plan describes reclamation objectives and specific reclamation/closure activities for mine pits, waste rock disposal facilities, tailing storage facility, water storage facility, mill and process plant, environmental control dams and other stormwater management structures, and ancillary facilities. Final grading and contouring are described for the Project area.

The Plan for the Ahafo South Project was developed for the anticipated operational condition of the facilities, tailings characteristics, site climatic conditions, and available construction materials. The Plan was also developed to be consistent with the following guidelines and regulations:

1. Standard practices of the International Finance Corporation (IFC);
2. Environmental Health and Safety Guidelines for Precious Metal Mining;
3. Guidelines addressed in the Government of Ghana Environmental Protection Agency Act 490;
4. Newmont Mining environmental guidelines for reclamation of tailings and other mining facilities; and
5. State of Nevada Regulations for Mine Reclamation in the absence of other regulations as a guideline.

These parameters include practices for post-operational water management and long-term stability. Reclamation objectives for the Plan include the following:

1. Returning as much of the affected area as possible to a condition where its pre-mining usage can resume. The primary pre-mining uses include cropland, livestock grazing, and small residential development.
2. All structures will be decontaminated, decommissioned, salvaged or demolished on the site according to the terms of the mining agreement. These include facilities, ancillary equipment and buildings.
3. Safe disposal of hazardous material, equipment and contaminated soils and steel structures.
4. Regrade and revegetate disturbed areas.
5. Implement the water treatment program.
6. Implement the environmental monitoring program.

MINE PITS

Reclamation objectives for open mine pits will be to assure public safety by restricting access to the pit area. Backfilling or partial backfilling of the open pits is not currently planned, but may be considered during later phases as warranted. It is assumed that after mining, pit walls will ravel to create a stable, final slope and as such, additional stabilization or regrading will not be necessary. Based upon current information, pit lakes may develop passively and partially fill some or all pits over time. However, surface drainage from the pits does not appear likely due to the relatively high annual evaporation rates (with respect to annual precipitation) at the site.

Available information suggests an absence of potentially acid generating (PAG) material within the planned mine pit boundaries, except for minor amounts of sulfide ore. It is assumed that any resulting pit lakes will not require water treatment; however future studies will be required to confirm this assumption in those pits where lake development is likely. Public access to the pit areas will be restricted by constructing earthen berms, brush barriers, and installing warning signs around the

perimeters to deter accidental access. Disturbed areas outside the footprint of the open pits will be recontoured such that the final topography is generally consistent with the adjacent landforms and avoid ponding along the pit perimeters.

WASTE ROCK DISPOSAL FACILITIES

Short-term reclamation objectives for the waste rock disposal facilities are to minimize potential for erosion, slope failures, and sediment transport from the waste rock surface and to facilitate final reclamation. Long-term objectives include preventing ponding, promoting controlled runoff surface water, and preventing erosion from the reclaimed surfaces. In order to achieve the reclamation objectives, reclamation will be performed concurrently as each lift is completed by regrading the waste rock slopes to 3.0H:1.0V (horizontal : vertical), with 4-m-wide horizontal drainage benches provided at a vertical spacing of 12 m.

Recontoured surfaces will be covered with 0.5 m of growth media on sloped areas and drainage benches, 0.15 m on flat surfaces, and reseeded. The closure plan for waste rock disposal facilities is based upon available information that indicates these facilities will only contain minor amounts PAG material, all of which will be encapsulated within the dumps.

PLANT SITE

The mill and process plant will be decommissioned prior to the demolition or salvage of any structures. Portable equipment of value including vehicles, furniture, and computers will be removed from site for subsequent reuse or salvage. Decommissioning the crushing and screening plant will be initiated once the last ore has been processed. The CIL plant will be decommissioned once all economic recoverable gold solution has been processed. Immovable assets that have been properly decommissioned, such as office and plant buildings, shall be transferred to the government of Ghana as described in terms of the mining lease. Contaminated soils from the spillage of oils and lubricants shall also be removed and placed in an approved disposal facility. Stripped areas in the vicinity of mill and process plant will be scarified, covered with 0.5 m topsoil, graded to match contours of surrounding topography, and revegetated.

TAILING STORAGE FACILITY

Reclamation of the tailing storage facility will commence upon termination of tailing deposition. Reclamation objectives for the tailing storage facility include controlling erosion, managing stormwater runoff, minimizing dust generation, and establishing vegetation on the facility. Based upon testing by NGGL, the tailing appear to be non-acid generating. Given currently available information, establishing a vegetated soil cover appears to be the most appropriate long-term reclamation strategy for the tailing storage facility. As currently planned, the cover would consist of a 0.5 m thick layer of oxide waste rock over the tailing surface, covered with 50 cm of suitable growth media. This cover would be reseeded with an appropriate native seed mix. The exterior slopes of the tailing embankment will be graded to 3:1 or flatter using oxide mine waste or other suitable material. The exterior face will be progressively revegetated as the final slope is established in order to reduce erosion and sediment transport from the embankment.

The south embankment of the tailing storage facility will be buttressed by the Apensu waste rock disposal facility, which will significantly limit the amount of exposed embankment slope in this area. Stormwater runoff from the top of the reclaimed tailing storage facility will be routed through a reclamation spillway constructed through the south embankment and outfall to the Apensu open pit.

Reclamation of the tailing surface will commence upon termination of tailing deposition in the storage facility. After removal of the pond in the low area adjacent to the final spillway, the tailing surface will be allowed to dry to the point where cover placement is possible without excessive deformation of the tailing surface. Drying is expected to take several months in the decant/final spillway area and could possibly require completion of capping during the following dry season. The tailing storage facility under-drainage system is expected to continue to operate for a number of years after completion of capping and revegetation as excess pore water continues to drain from the tailing.

The under-drainage system will be constructed throughout the tailing basin and will serve to reduce the phreatic surface within the tailing. Drains will report to a collection sump, which will be dewatered by pumping from an access riser pipe. After mining activities have been terminated, water from under-drainage will be treated at the process plant and released into the water storage facility.

WATER STORAGE FACILITY

The water storage facility will be created by impounding water against the upstream side of the north embankment of the tailing storage facility. The water storage facility will remain operational after mine closure and reclamation of the site, in perpetuity. Extreme storm events will be managed by the overflow spillway located near the southeastern portion of the reservoir. Water passing through the spillway will be routed via a series of diversions to the Awonsu tributary of the Tano River.

ENVIRONMENTAL CONTROL DAMS

Upon completion of closure and reclamation activities, accumulated sediments will be removed from the areas upstream of the environmental control dams. Where possible, sediment and topsoil collected from the base of the environmental control dams will be transported to the nearest topsoil stockpile or redistributed in areas that require additional reclamation growth media. The environmental control dams will then be breached to restore free flowing conditions.

ANCILLARY FACILITIES

Ancillary features will be sorted into salvageable versus non-salvageable items. Any non-salvageable and non-saleable materials will be disposed of and buried in waste rock disposal facilities. All building structures will be demolished except those as being transferred to the Government of Ghana. Electric power line support structures will be left for public use. High voltage power lines from maintained by the Government of Ghana will remain functional to the main substation. Overhead power lines and substations providing power to the mine are to be removed. Overhead power lines feeding villages shall be kept in place and turned over to public domain. Contaminated soils in fuel station containment areas will be removed and placed in an approved disposal facility.

Final grading and revegetation of the site will involve establishing soil stability, minimizing erosion and establishing a sustainable post-closure land use scenario. Grading of the site shall be consistent with

surrounding topography. Grading shall incorporate sufficient drainage channels to divert surface water runoff during high precipitation events and shall avoid ponding of water on site. The final stage will be establishing a safe land use scenario that will sustain subsidence agriculture for the local community.

MONITORING

Procedures for short-term and long-term monitoring of the mine site after closure will be established to ensure that mining activities do not affect surrounding areas and is a continuation of the operational monitoring program. The items scheduled to be monitored should not be considered as an all-inclusive monitoring list, and will be updated as mining and reclamation activities progress. An environmental report will be submitted periodically to the Ghanaian EPA.

Short-term monitoring will consist of monitoring the groundwater monitoring wells, dust monitoring, revegetation progress, surface water run off quantity and quality, open pit condition monitoring, pit lake water quality, and tailing storage facility effluent quantity and quality. Monitoring will be performed once per month for approximately three years. Monitoring groundwater, surface water, and pit lake water shall consist of sampling for a selected list of parameters. Air monitoring stations will be installed and sampled for airborne dust particles. Revegetation will be inspected for erosion, biodiversity and growth. Long-term monitoring will consist of a combination of observations, well measurements, and sampling for water and air quality on a less intensive schedule than short term monitoring. The proposed schedule for groundwater and surface water sampling, and site observations will be monthly for five years and laboratory testing of pit lake water will be semi-annually for five years. This proposed schedule shall be reconsidered as reclamation and closure activities come to a close. Monitoring of groundwater, surface water, and pit lake water shall consist of sampling for a selected list of parameters.

RECLAMATION COSTS

Reclamation costs associated with work described above were estimated by MFG, Inc. (2005) using unit rates and costs prepared by Lycopodium Pty. Ltd. based upon experience with similar projects in Ghana. Life-of-mine facilities configurations and layouts were obtained from NGGL drawings and from design drawings prepared by Knight Piesold Pty. Ltd. Estimated closure and reclamation costs associated with closure of the facilities described above are summarized in **Table 2-5**. These costs are based upon current (2005) U.S. Dollars and have not been adjusted to their present worth or for inflation.

NGGL would earmark \$6.24 (US) per ounce of gold generated over the operational mine life to accrue adequate funds to complete final closure and reclamation of the Ahafo South Project. Approximately \$10 million (US) has been budgeted for concurrent reclamation activities during the operations phase of the Project. Estimated production of 6.8 million ounces would provide approximately \$42 million (US) for closure and reclamation.

Facility	Estimated Closure Cost (2005 US\$)	Year Incurred (Year 1 = 2005)
Open Pits	\$525,000	Years 2 – 6, & 15
Waste Rock Disposal Facilities	\$5,889,853	3 – 10
Mill and Process Plant	\$5,141,553	15 – 16
Tailing Storage Facility	\$14,996,000	3 – 16
Water Storage Facility	\$2,064,000	15
Environmental Control Dams and Stormwater Management Facilities	\$403,455	15
Ancillary Facilities	\$1,367,404	16
Subsurface Drainage and Water Treatment	\$1,500,000	15 – 16
Short-Term Monitoring	\$972,000	15 – 17
Long-Term Monitoring	\$770,000	18 – 22
Total Closure Cost (without contingency)	33,629,265	Years 2 – 22

Source: MFG 2005.

OCCUPATIONAL HEALTH AND SAFETY

NGGL currently maintains and actively manages an extensive occupational health and safety program (“Loss Control”) at the Ahafo South Project construction site. This program, including appropriate training and monitoring procedures, will also be implemented at Ahafo South Project once operations commence to ensure that high standards of health and safety are maintained. In addition, NGGL will implement Hazard Evaluation/Risk Analysis procedures as outlined in IFC Mining Guideline.

On-site staff, responsible for ensuring that health and safety policies and procedures are properly implemented and recorded, manages the Loss Control program. Policies and procedures are specified and updated annually, or as necessary, based on site-specific requirements. Detailed descriptions are provided to all employees and contractors prior to initiating work-related activities. Primary components of the manual are:

- **Policies:** Specifies NGGL health and safety policies and procedures associated with all aspects of occupational health and safety.
- **Prevention Programs:** Specifies the prevention programs, safety meetings, reporting procedures and contractor requirements associated with accident prevention measures to be implemented for all aspects of mine construction, operation and closure.
- **Procedures:** Specifies specific procedures that must be completed if, and when, an accident occurs involving any person working on NGGL property or associated projects.
- **Health and Hygiene Program:** Specifies the known hazards associated with NGGL operations, outlines programs for respiratory and auditory protection, and describes the monitoring programs utilized to assess exposures and determine required remedial actions, if necessary.

- **Required Authorizations:** Authorizations are specifically required for various activities that are deemed hazardous. These activities require prior notification and authorization to ensure proper safety precautions are implemented before commencing the activities. Activities subject to this requirement include confined-space entry, heat exposure areas, high-voltage and exposed machinery, excavations/trenches, and borrow area excavations.

TRAINING

The Loss Control training program is provided to all new employees and contractors working on NGGL projects. The program involves training relative to worker responsibilities, unsafe working conditions, personal protective equipment (PPE), company policies, housekeeping, and basic safety rules. NGGL has developed and implemented specific training programs relative to the following areas in order to minimize employee exposure to potentially hazardous chemical substances or environments.

- Nature of hazardous materials;
- Selection of applicable PPE;
- Selection and use of a respirator;
- Respirator fit testing, maintenance, cleaning and storage; and
- Respirator limitations.

In addition, NGGL has developed specific training programs for all employees relative to the type of work to be conducted. Specific training programs are targeted for the following employee groups.

- Management level;
- Supervisor level;
- New-hire;
- Refresher; and
- Contractor.

Operators at the Project site will be trained in all aspects of their work stations, hazard recognition, chemical handling procedures, first aid, personal hygiene, electrical safety, rigging and lifting, vehicle safety, pond safety, fire safety, safety practices for working around machinery with moving parts, and other topics that may relate specifically to a job assignment or physical location at the Project. Health and safety training programs are described in **Table 2-6**.

TABLE 2-6 Health and Safety Training Programs				
Course	Personnel	Frequency	Duration	Instruction
New-hire Training	All new hires exposed to mine hazards	Once	24 hours	Employee rights Supervisor responsibilities Self-rescue Respiratory devices Transportation controls Communication systems Escape and emergency evacuation Ground control hazards Occupational health hazards Electrical hazards First aid Explosives Toxic materials
Task Training	Employees assigned to new work tasks	Before new assignments	Variable	Task-specific health and safety procedures Supervised practice in assigned work tasks in nonproductive duty
Refresher Training	All employees who received new-hire training	Yearly	8 hours	Required health and safety standards Transportation controls Communication systems Escapeways, emergency evacuations Fire warning Ground control hazards First aid Electrical hazards Accident prevention Explosives Respirator devices
Hazard Training	All employees exposed to mine hazards	Once	Variable	Hazard recognition and avoidance Emergency evacuation procedures Health standards Safety rules Respiratory devices

Source: Newmont 2003.

Foremen and supervisors will receive additional training on these topics through regular safety meetings. Assistance will be provided by the Fire and Safety Officer in the form of instructions, procedures, inspections, and safety training. Safe work practices are required by NGGL. In addition, management would review all accidents with employees to perform a “lessons learned” exercise which guides employees through the accident so that it is clear where new and or additional training will be needed.

MATERIAL HANDLING

NGGL has developed a material handling program specific to chemicals and other materials located on NGGL properties. These specifications and handling procedures include information regarding the following materials and activities:

- Cyanide transportation, storage, handling and mixing;
- Caustic soda transportation, storage, handling and mixing;

- Sodium hypochlorite transportation, storage, handling and mixing; and
- Explosives and accessories handling, storage and use.

Specific procedures developed with regard to material handling, include the following:

- Spill response actions;
- Disposal of shipment containers;
- Emergency evacuations;
- Mixing and usage precautions;
- PPE requirements;
- First-aid procedures; and
- Clearly mark and label all materials and post Material Safety Data Sheets adjacent to storage and use areas.

WORK STATION MONITORING

NGGL has developed a workstation monitoring program intended to evaluate, document and monitor potential physical and chemical stresses in the workplace. Monitoring programs have been developed for employees with respect to applicable environmental parameters. Main components of the monitoring program are listed below:

- Periodic monitoring of exposure control methods to assess effectiveness in reducing or eliminating worker exposures;
- Periodic monitoring of employees potentially exposed to hazardous workplace stresses, incorporating both short-term and long-term exposure levels. Workers are monitored primarily for metals;
- Sample collection and analysis including air quality, blood samples, and observational data;
- Observation of worker behavior during normal activities;
- Worker interviews to determine whether exposures are common characteristics of the specific work environment; and
- A quality assurance/quality control (QA/QC) program to ensure proper data collection.

NGGL maintains a professional on-site staff, in addition to consultants and other technical professionals, to ensure all monitoring programs, data collection techniques and data interpretation are properly implemented.

PERSONAL PROTECTIVE EQUIPMENT

Personal protective equipment will be mandatory under NGGL policy for all activities based upon job risk assessment in accordance with international best practices. At a minimum, all employees will be required to wear hard-hats and steel toed boots in designated work areas. Rubber gloves, rubber arm protectors, rain suit coveralls, face shields, splash goggles, safety belts and lanyards, dust respirators, hearing protectors, welding hoods and goggles, and high voltage insulated gloves will be available and required where appropriate. Safety showers will be provided at locations within the processing plant, work shop, warehouse, and laboratory.

QUALITY PROCEDURE DOCUMENTATION

NGGL has generated safety procedures, standard operating procedures, and quality procedures to cover all aspects of construction and operational phases of the Project, including documents on transportation, handling chemicals, operating machinery, and emergency response procedures.